



# CHEFTOP-BAKERTOP MIND.Maps™ PLUS

USAGE MANUAL



## SAFETY REGULATIONS AND COOKING ADVICE

<b>Safety regulations</b> .....	<b>4</b>
<b>General usage instructions</b> .....	<b>6</b>
COOKING ADVICE .....	6
BLACK-OUT .....	6
TROLLEY LOADING AND USE (ONLY FREE-STANDING TROLLEY OVENS).....	7
<b>Using Master Touch</b> .....	<b>8</b>

## MAINTENANCE

<b>Cleaning</b> .....	<b>42</b>
<b>After-sales support</b> .....	<b>43</b>
<b>Inactivity</b> .....	<b>44</b>
<b>Disposal</b> .....	<b>44</b>
<b>Guarantee certificate</b> .....	<b>44</b>
<b>Warranty</b> .....	<b>45</b>

## USE

<b>SAFETY REGULATIONS FOR USE</b> .....	<b>4</b>
<b>COOKING ADVICE</b> .....	<b>6</b>
<b>UIP (UNOX INTELLIGENT PERFORMANCE)</b> .....	<b>10</b>
<b>MENU SET</b> .....	<b>12</b>
HOW TO SET THE COOKING PARAMETERS.....	13
HOW TO SET A MANUAL COOKING CYCLE.....	14
FURTHER INFORMATION: CORE PROBE.....	15
STARTING A COOKING CYCLE.....	19
COOKING END.....	24
SAVING A COOKING CYCLE.....	25
<b>MIND.MAPS MENU</b> .....	<b>26</b>
<b>PROGRAMS MENU</b> .....	<b>28</b>
MY PROGRAMS.....	28
MY MIND.MAPS.....	29
<b>MULTI.TIME MENU</b> .....	<b>30</b>
NEW MULTI.TIME.....	31
MY MULTI.TIME.....	33
MY MENU.....	34
<b>MENU CHEFUNOX</b> .....	<b>36</b>
CHEFUNOX MULTI.TIME.....	36
CHEFUNOX AUTOCOOK/AUTOBAKE.....	38
<b>MISE EN PLACE MENU</b> .....	<b>39</b>
NEW MISE EN PLACE.....	40
MY MISE EN PLACE.....	42
MY MENU.....	42
<b>ROTOR.KLEAN MENU</b> .....	<b>44</b>
SCHEDULING WASHES.....	45
FILLING THE DETERGENT TANK.....	46
<b>READY.COOK MENU</b> .....	<b>47</b>
<b>STATS DDC MENU</b> .....	<b>48</b>
SETTING GOALS.....	48
HACCP DATA.....	49
CONSUMPTION.....	49
<b>SETTINGS</b> .....	<b>50</b>
<b>OVEN-USER INTERFACE</b> .....	<b>57</b>
<b>CLEANING</b> .....	<b>60</b>
<b>AFTER-SALES ASSISTANCE</b> .....	<b>61</b>
<b>INACTIVITY</b> .....	<b>62</b>
<b>DISPOSAL</b> .....	<b>62</b>
<b>CERTIFICATION</b> .....	<b>63</b>

### SAFETY REGULATIONS FOR USE

- Following any procedures other than those indicated in this manual when using or cleaning the appliances is considered inappropriate and may cause damage, injury or death, as well as invalidating the warranty and relieving UNOX of all liability.
- Children must not play with the appliance. User cleaning and maintenance must not be carried out by children without supervision.
- Children must be supervised to ensure they do not play with the appliance.
- This appliance can only be used for cooking food in industrial and professional kitchens by qualified personnel, who have completed regular training courses. Any other use is not compliant with the scope of use and is therefore hazardous.
- If the appliance does not function or if there are any functional or structural alterations, disconnect the electricity, water and gas supplies (only for gas ovens) and contact an UNOX-authorized customer service centre. Do not attempt to repair the appliance yourself. For any repairs, please request UNOX original spare parts.
- Failure to observe these regulations may cause damage, injury or death, and also invalidates the warranty.
- To ensure that the appliance is in perfect condition in terms of use and safety, maintenance and inspections should be performed at least yearly by an authorised support service centre.
- The humidity sensing system must be calibrated when the oven is first installed (contact the UNOX Service Centre) and as and when the oven requires it.

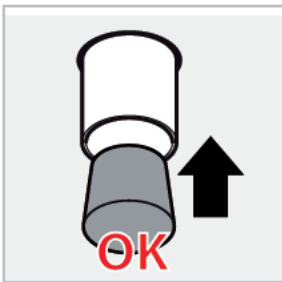

If the BAKERTOP MIND.Maps™ oven cannot be permanently connected to a drainage system, the end can be shut off using the cone-shaped stopper supplied in the starter kit. When the end is closed with the plug **DO NOT** use the wash cycle or wash the chamber with large amounts of water as this could cause flooding.

### RISK OF BURNS and INJURY!

- During cooking until all appliance parts have cooled, be careful to:
- Only touch the appliance control components or the handle because the external parts are extremely hot (temperature above 60°C/140°F).
- Open the door (where necessary) very slowly and carefully, and beware of extremely hot steam coming from the oven cavity.
- Wear appropriate protective thermal clothing to move containers, accessories and other objects inside the oven cavity.
- Be extremely careful when removing trays from the oven cavity.
- Extract the probe from the core of the food before removing the trays from the oven, and place it in the external probe holder. Before extracting the tray, check that the probe cable is not in the way. Handle the probe with care because it is extremely sharp and, after use, can be very hot.
- During the COOL function (cavity cooling), the appliance supplies water and keeps the door closed to prevent injuries caused by hot steam.
- Do not remove or touch the protective fan covering, the fans or the heating elements while the appliance is turned on and until they have completely cooled.
- Carefully read the product safety data sheet before handling and using the detergent.
- Do not open the oven door during washing as this could cause injury to eyes, mucous membranes and skin caused by contact with the cleaning chemicals used. These chemicals are sprayed by the rotor within the cooking chamber and moved by strong air currents.



## Safety regulations

- When carrying out maintenance on the oven water circuit, you must use PPE specific for the detergent (see the product safety data sheet). Specifically, gloves and goggles must be used since there could be detergent residue in parts of the circuit that could be pressurised.
- Do not tamper with the oven water circuit in any circumstances because this could cause damage, injury or death. The oven water circuit begins with a 3/4" connector, with a non-return valve built in, and includes all the subsequent piping and accessories.
- If the appliance glass is chipped or damaged, it must be replaced immediately by contacting an authorised support service centre. **Do not use the oven. Risk of exploding glass.**

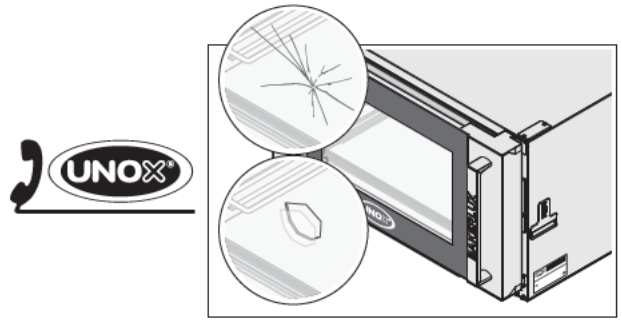

### Only for free-standing trolley ovens:

- Always lock the front wheel brakes after loading the oven cavity and at all times when they do not need to be moved.
- Always lock the trays into their guides.
- Be extremely careful when moving the trolley because the trays may contain hot fluids that may spill or the trolleys may fall over (for example if moved across uneven floors or through doors).

### RISK OF FIRE

- Before using the appliance, make sure that there are no non-compliant objects (instruction manuals, plastic bags, etc.) or detergent residues inside the oven cavity. Also make sure that the flue is free of obstructions and that there are no flammable materials in the vicinity.
- Do not place sources of heat (e.g. grills, fryers, etc.), highly flammable substances or fuels (e.g. gasoline, petrol, bottles of alcohol, etc.) near the appliance.
- Do not use highly flammable food or liquids while cooking (e.g. alcohol).
- Always keep the oven cavity clean by cleaning every day after each use. Grease or food residues could catch fire if not removed.

### RISK OF ELECTRIC SHOCK

- Do not open the compartments marked with these symbols. Only qualified personnel authorised by UNOX may access these compartments. Failure to observe this regulation invalidates the warranty and may cause damage or injuries including death.

## **Only for gas ovens**

- Always keep the smoke exhaust pipe in the top portion of the oven free of obstructions (e.g. objects, trays, etc.).
- Always switch on the cooker hood when using the appliance if installed.
- If the appliance is connected to a flue, this must be:
  - kept free of any obstructions - risk of fire.
  - regularly cleaned and inspected as required by the relative standards for the country where it is used - risk of fire.
- The appliance must be installed away from air currents or drafts - risk of fire.
- Make sure that ventilation inlets and the underlying part of the appliance are clean and free of obstructions (e.g. objects near the appliance).
- If you can smell gas:
  - immediately shut-off the gas supply;
  - immediately ventilate the area;
  - do not turn on any electrical switches or create sparks or open flames;
  - use an external telephone to contact the gas utility company.

## Notes

---

---

---

---

---

---

---

---

---

---

---

---

---

---

---

---

---

---

---

---

---

---

---

- ⚠ **Before using the appliance, read section "Safety regulations for use" carefully**
- ⚠ **If cooking large amounts of greasy foods, place an empty tray without holes on the lowest grill rack in the oven. Alternatively, use an appropriately sized container.**

- When using the appliance for the first time, be sure to clean the inside of the oven cavity and the accessories thoroughly (see the **Cleaning** section on page **64**); let the oven run empty at maximum temperature for 1 hour to eliminate any unpleasant odours created by the protective grease used in the factory.
- When the oven door is opened, unless the "COOL" function has been selected, heating and fan operation stops automatically. The built-in fan brake is activated (the fan continues to rotate for a short time only).
- If the appliance is left running for more than 15 minutes without an operating or automatic cleaning mode being selected, stand-by is automatically activated to save energy.
- To exit STAND-BY mode, tap the START/STOP button.
- Use the appliance where the room temperature is between +5°C and +35°C.
- Do not salt food inside the oven cavity. If this is not possible, clean the oven as soon as possible (see the **Cleaning** section on page **64**).
- To prevent boiling, do not fill containers with liquids or foods that liquefy with heat in quantities exceeding those that can easily be kept under control.

- ⚠ For safety reasons, the last tray should NEVER be placed at a height greater than 160 cm. If it is necessary to do so, **apply the sticker contained in the "Starter Kit" at a height of 160 cm.**

### COOKING ADVICE

- It is always better to preheat the oven to a temperature at least 30-50°C higher than is required for cooking, in order to compensate for the heat lost when opening the door.
- Use the UNOX grills and trays. Try to distribute food uniformly on the trays and avoid overlapping foods or overloading the trays.
- Always respect the loading instructions for your appliance.

### BLACKOUT

In the event of a blackout or shutdown, on restart the appliance will resume the program that was running previously (e.g. a Multi.time recipe). The duration of the cooking cycle may be extended by a maximum of 2 minutes.

When navigating and setting parameters only use your finger (which must be clean and dry); avoid using tools such as forks, spoons, etc. The pen provided must only be used for drawing the cooking curves on the Mind.Maps menu and for signatures.

### USING THE CORE PROBE

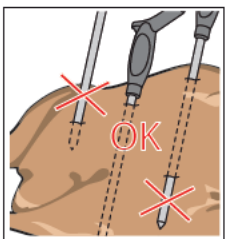

During the cooking cycle, the probe detects the temperature at the core of the product. It reaches the temperature set by the user when the product is perfectly cooked both on the surface and on the inside. The core probe must be inserted deep into the food being cooked. The probe head must reach the product's "core" i.e. the innermost portion without piercing its way through the other side. If the food you are cooking is relatively thin, insert the probe parallel to the oven tray. When dealing with several foods, insert the probe into the smallest product; when this has reached the required core temperature (and therefore cooking is stopped) take the product out of the oven, insert the probe into the smallest remaining piece and restart the cooking cycle.

- ⚠ Handle the probe with care because it is extremely sharp and, after use, the needle is very hot.
- ⚠ Extract the probe from the core of the food before removing the trays from the oven, and place it in the external probe holder (never leave it dangling inside/outside the oven cavity).
- ⚠ Before removing the tray, check that the probe cable is not in the way.

### LOADING AND USING THE TROLLEYS

(ONLY FOR FREE-STANDING TROLLEY OVENS)

! Use only UNOX trolleys, trays and grills.

- Load the trolleys without overloading them: it is normal for the trolley to be pushed downwards and be lower in height, depending on how full the trays are.
- The trolley is loaded into the oven using the bottom trolley guides.
- Lock the trays into place when moving the trolley as shown in the figure.
- Always lock the front wheel brakes after loading the oven cavity and at all times when they do not need to be moved.
- Be extremely careful when moving the trolley because the trays may contain hot fluids that may spill or the trolley itself may tip over (for example if moved across uneven floors or through doors).

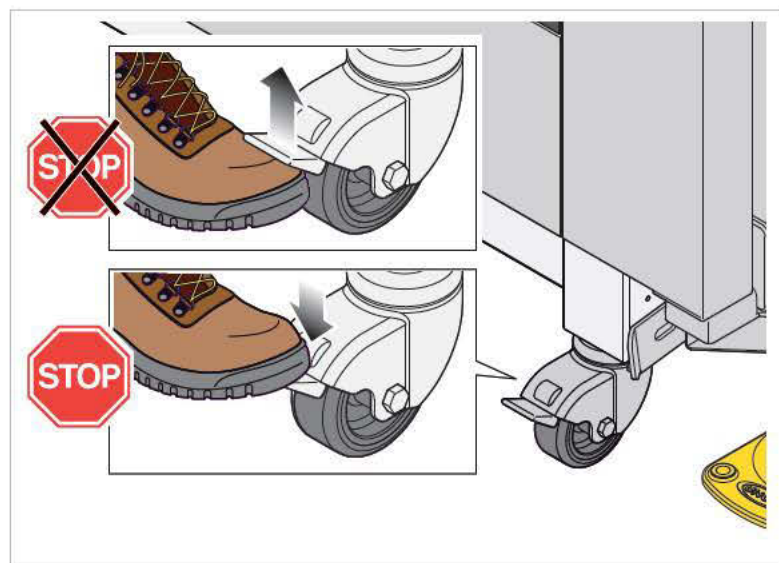
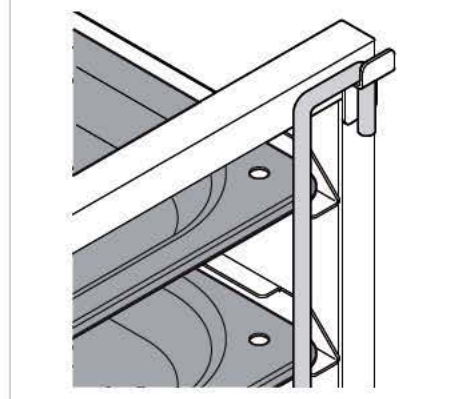
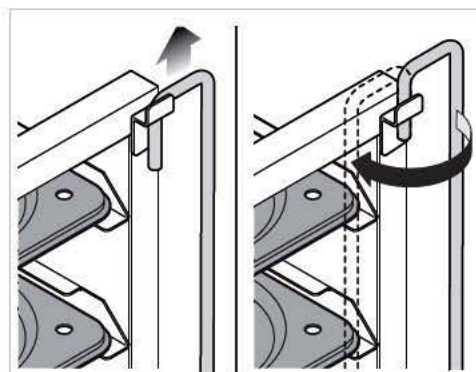



# CHEFTOP-BAKERTOP MIND.Maps™ PLUS

Use

The "MY HOME" functions enables access to a list of recipes selected as "favourites".

 [section "MY HOME" special function" on page 13](#)

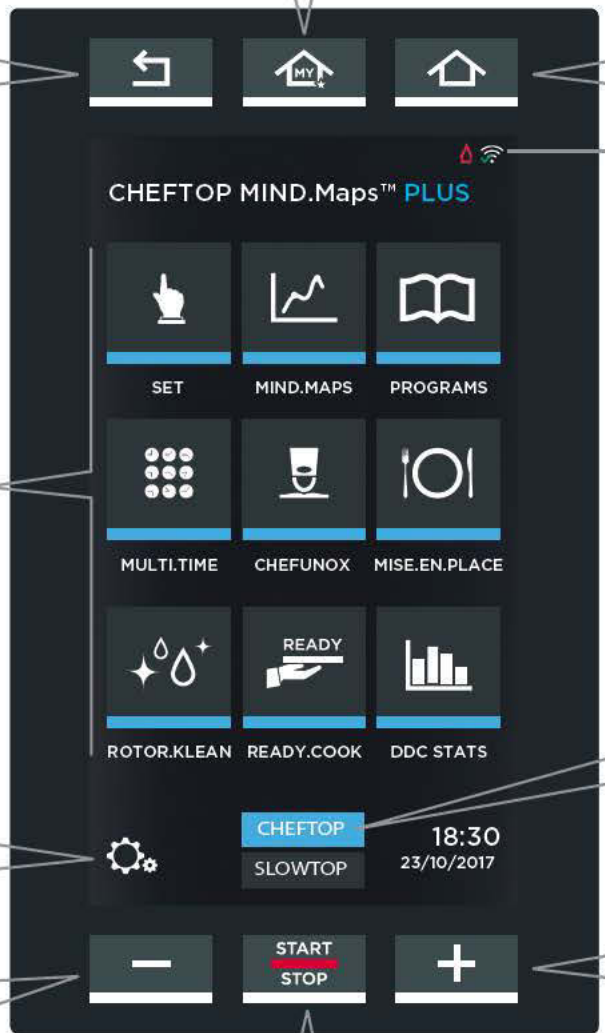

Go back to the previous page

Go back to main page

See following page







User parameter settings (date/time, unit of measurement, etc.) [section "Settings" on page 54](#)

Decrease values

Increase values

This oven allows you to control the connected accessories with one control panel (e.g. SLOWTOP). Tap the lower icon to use them.

The **START STOP** button starts a cooking cycle [section "Starting a cooking cycle" on page 23](#)

	Wi-Fi connection active		3G connection active		Ethernet connection active
	Wi-Fi connection NOT active		3G connection NOT active		Ethernet connection NOT active



# CHEFTOP-BAKERTOP MIND.Maps™ PLUS

Use



## SET

This allows cooking cycles in which the user has to set the parameters manually for each cycle (e.g. temperature, cooking time, etc.).



[More information on page 16](#)



## PROGRAMS

This menu provides access to a list of cooking cycles saved previously using the "SET MENU".



[More information on page 32](#)



## MULTITIME

In the modern kitchen, needing to cook foods with different cooking times but in the same conditions (temperature, steam, etc.) simultaneously is not uncommon. With the "Multi.time" menu you can to use the oven in a continuous cycle and set up to 10 timers that notify you when each dish is ready.



[More information on page 34](#)



## CHEF UNOX

This menu offers a series of recipes preset by UNOX: the perfect end result, guaranteed.



[More information on page 40](#)



## MISE EN PLACE

The "Mise en place" menu allows you to remove products with different cooking times, placed in the oven at different times, all at the same time.



[More information on page 43](#)



## ROTOR.KLEAN

This provides access to a list of washes and lets you start the most suitable wash for your needs.



[More information on page 48](#)



## READY.COOK/READY.BAKE

This is used to access some preset programs, to start certain cooking methods quickly.



[More information on page 51](#)



## DDC STATS

This menu allows you to control consumption and HACCP data.



[More information on page 52](#)

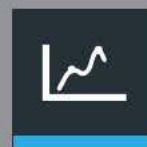

## MIND MAPS

A new simple, quick and intuitive way to set cooking parameters.



[More information on page 30](#)



## UIP (UNOX INTELLIGENT PERFORMANCE)

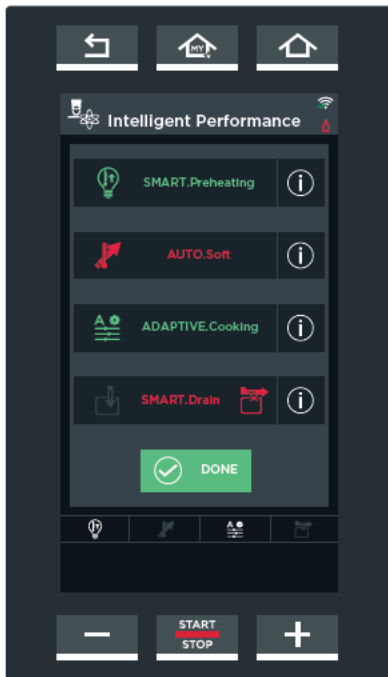

If selected, UIP technology allows you to **monitor** every preheating and cooking process constantly.

Thanks to this feature, the oven software is able to manage, where necessary, **changes** to the user settings **fully autonomously** without the operator needing to intervene. This guarantees a perfect cooking result every time.

### Available functions:

#### SENSE.Klean

This suggests the most suitable washing program for the level of dirt detected in the oven.

#### SMART.Preheating

This function automatically adjusts the time and temperature of the preheating cycle, to guarantee uniform cooking and energy efficiency.

#### AUTO.Soft

This function automatically adjusts the temperature increase speed to improve cooking evenness when cooking delicate foods

#### ADAPTIVE.Cooking

This function automatically optimises the cooking process parameters, according to the oven load, the time the door is open, and the readings from the oven sensors

#### SMART.Drain

This function associates the best position for the fat collection valve in the tank to the program. The program cannot be run if the valve is not positioned correctly. For information on managing the "Pollo" valve, please see the relevant manual.

If necessary, press the  button to show the function description on the display.

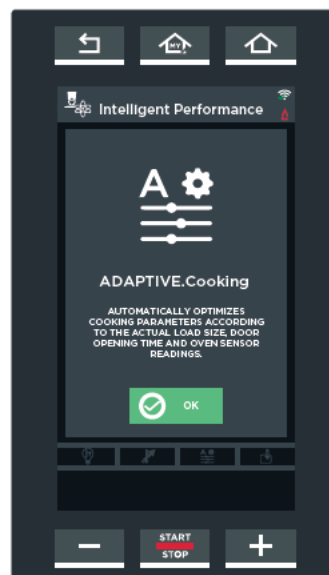
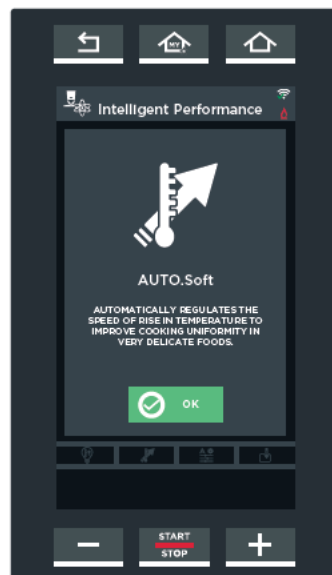
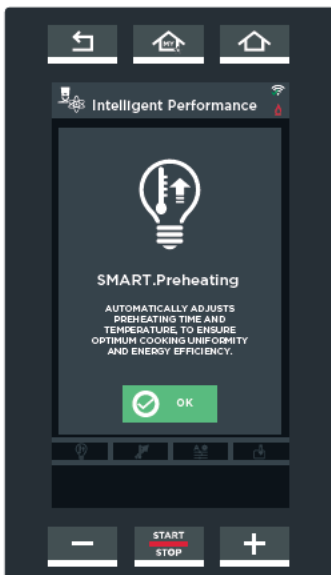

## "MY HOME" special function

From the preheating screen (both classical and SMART) it is possible to mark the recipe during preheating as "favourite" (points ① - ②).

Subsequently, by pressing the MY HOME button (point ③), all recipes marked as such will be displayed: the function is particularly useful to easily find recipes that are frequently used.

To delete a recipe from the "MY HOME" screen, hold down the icon for at least three seconds (point ④). A screen will appear that prompts to confirm the deletion (point ⑤): by selecting "YES" the recipe will be removed from the list.

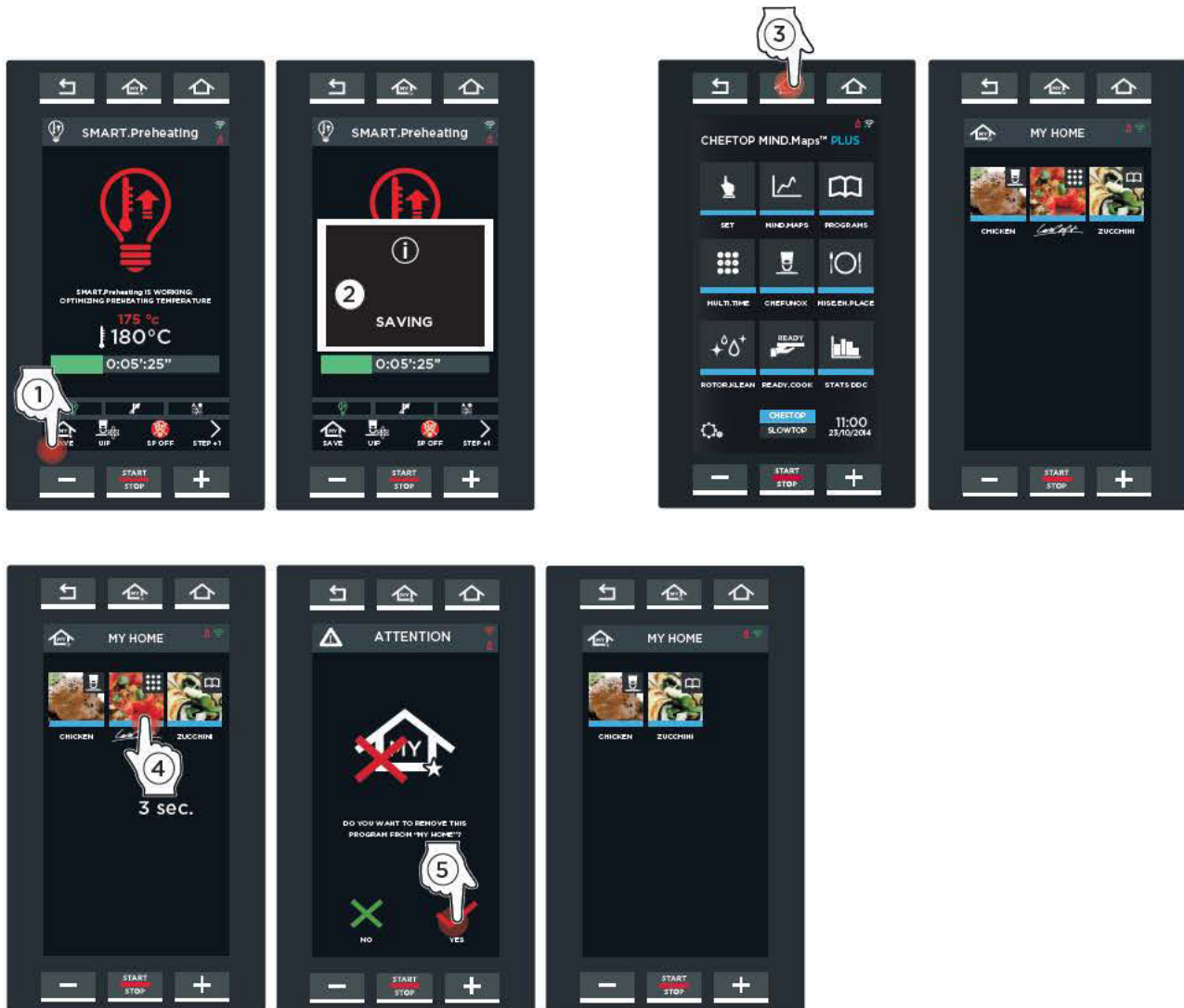





## Special “MULTI PRODUCT” function

With the **Multi-product** function, very useful instructions are given at the end of each step regarding the cooking being executed (e.g. add mushrooms to the first tray from the top).

In addition to this note, to facilitate operations an image of the plate (if entered) will appear on the screen.

- ① Set the cooking parameters of the first step  
 [section “HOW TO SET A MANUAL COOKING CYCLE” on page 18](#)
- ② tap the “BUZZER”  button;
- ③ assign a photo to the recipe (optional step);
- ④ write a note that you want to appear at the end of the step;
- ⑤ confirm with “OK”.

Repeat the operations described in points from ① to ⑤ until you have added all the notes needed (up to a maximum of nine - maximum number of steps that can be set).

- ⑥ When all of the notes have been uploaded, start cooking with the “START/STOP” button.
- ⑦ When the time provided for the first step comes to an end, the inserted note (e.g. add mushrooms to the first tray from the top) and the image (if uploaded) of the tray on which to intervene appear on the screen. Confirm by pressing the “OK” button: the cooking will automatically start again with the parameters set for the second step.

- ⓘ If notes need to be added during cooking, press the button 



## Special optional “PRESSURE STEAM” function

With the **Pressure Steam** function (an optional function available only for BAKERTOP Mind.Maps™ ovens) it is possible to cook plates that require large quantities of steam (e.g. Jiaozi - Chinese Dumplings).

- 1 Activate the function by pressing the corresponding icon: this will go from grey to blue.

! Each cooking step is independent, i.e. there can be steps with the function activated, others with the function disabled because it is not necessary: in this last case, to disable the function simply press the corresponding icon (grey icon = function NOT active)

- 2 A screen with pre-set parameters appears:

- 80°C preheating
- 1 minute and 10 seconds cooking time
- 100°C cooking temperature
- 120% maximum humidity

! These values can be changed as needed as described in the section dedicated to manual cooking.

- 3 Then, set all the steps you need.

! **For further details on the setting of steps see section HOW TO SET A MANUAL COOKING CYCLE on page 18.**

- 4 Then, start the cooking by pressing the “START/STOP” BUTTON.

! Each cooking step is independent, i.e. there can be steps with the function activated, others with the function disabled because it is not necessary.



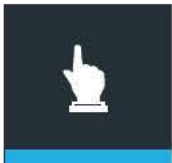

## Menu Set

This enables "manual" cooking, where the user needs to set the following cooking parameters:

- cooking time or core temperature (the two parameters reciprocally exclude each other);
- temperature in oven cavity or Delta "T" (each of these parameters reciprocally excludes the other);
- steam input/extraction in the cavity;
- airflow speed.

The set cooking cycle can be saved for future use as required.

 [section Saving a cooking cycle on page 29](#)

### Hyper Smoker

the icon only appears if the optional smoker is installed. For information on using the hyper smoker accessory, please see the relevant manual.

### Cooking time

(from 0 minutes to 9h:59min:59sec then INDEFINITE, i.e. the oven operates continuously)

Oven cavity temperature (from 30°C to 260°C).

### STEAM.Maxi™

Steam input to cavity

"Normal" airflow speed

\*Hyper Smoker: select the length of wood

The icons show which UIP functions are active

Set the preheating step

UNOX INTELLIGENT PERFORMANCE (UIP)

 [section "Further information: UIP \(UNOX INTELLIGENT PERFORMANCE\)" on page 22](#)

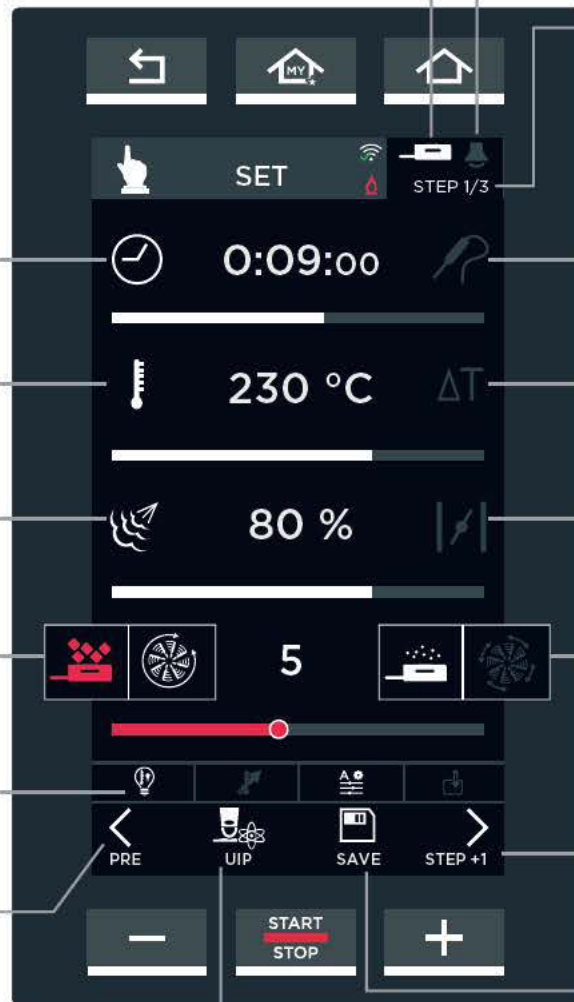

### Buzzer

tap this icon to enable/disable the beep at the end of each step  
green = beep ON  
gray = beep OFF

It also allows you to activate the MULTI-PRODUCT function

 [see page 14](#)

### STEP

This icon shows the number of steps being set.

### Core temperature

Setting the target core temperature

 [section "Further information: core probe" on page 19](#)

### Delta "T" temperature

(from 0°C to 120°C)  
Temp. in cavity/Core temp. = Temp. Delta "T"

### DRY.Maxi™

steam extraction from cavity

### Pulsed air flow speed

(the fan turns off when the oven has reached the temperature)

\*Hyper Smoker: select the length of wood

Set steps 1 to 9

Save the parameters set  
 [section Saving a cooking cycle on page 29](#)



# 1 HOW TO SET THE COOKING PARAMETERS

**FIG. S3****SLIDER BAR METHOD**

- 1 Tap the symbol of the parameter you want to set. The symbol will then change colour.
- 2 Tap the horizontal bar (this lights up) and drag the slider to the desired value; after three seconds of inactivity, the slider bar disappears.

**FIG. S2****BUTTON MODE** − +

- 1 Tap the symbol of the parameter you want to set. The symbol will then change colour.
- 2 Tap the value to be set (for the “time” parameter, modify the hours, minutes or seconds separately).
- 3 Use the − + buttons to modify the value.

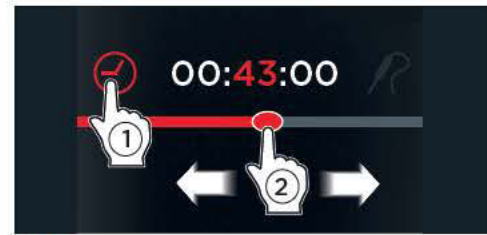
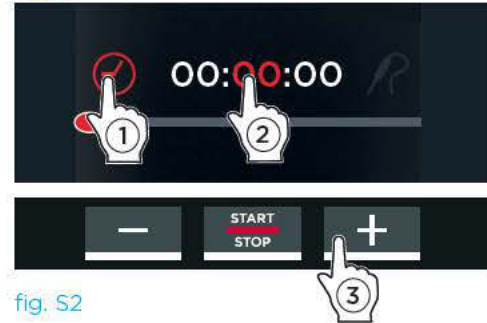
**fig. S1****fig. S2**

## Notes

---

---

---

---

---

---

---

---

---

---

---

---

---

---

---

---

---

---

---

---

---

---

---

---

## 2 HOW TO SET A MANUAL COOKING CYCLE

Each manual cooking cycle is made up of a minimum of 1 and a maximum of 9 STEPS, each with different cooking parameters + an initial preheating phase ("PREHEATING"), which is optional but always recommended.

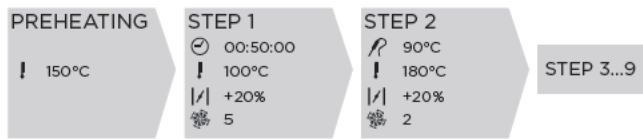

Example of cooking cycle involving more than one step, where some are timed and others use the core probe. Step 3-9 are not needed and therefore have not been set.

- ❗ To enable use, a cooking cycle must contain at least one STEP.
- ❗ Cooking does not necessarily require all nine STEPS: only set the steps which are required.
- ❗ The appliance automatically passes from one STEP to the next.

After setting the relevant functions (preheating, duration, etc.), you have the option to use UNOX INTELLIGENT PERFORMANCE (UIP) technology. This guarantees perfect cooking results every time.

📖 [section "Further information: UIP \(UNOX INTELLIGENT PERFORMANCE\)" on page 22](#)

### 2A PREHEATING SETTINGS

To set the preheating STEP:

- 1 **fig. S3:** tap the symbol 
- 2 **fig. S4:** tap the icon "TEMPERATURE" or "DELTA T";
- 3 **fig. S4:** use the "+ and -" BUTTONS or drag the slider bar to set the desired value. If you do not want preheating to be interrupted once the set temperature (e.g. 130°C) has been reached, you can insert a time (e.g. 9 minutes) by dragging the "CLOCK" field slider bar.

❗ It is always better to preheat the oven to a temperature at least 30-50°C higher than is required for cooking, in order to compensate for the heat lost when opening the door.

- 4 **fig. S4:** tap the  symbol to return to the parameter setting screen.

#### fig. S5

An acoustic signal (if active\*) indicates the end of preheating, i.e. the set temperature has been reached.



fig. S3

fig. S4



fig. S5

\* Tap it to **activate** (green icon) or **deactivate** (white icon) the beep at the end of the STEPS

## 2B SETTING THE PARAMETERS

Set, according to need:

- ① the **cooking time** (from 0 minutes to 9h:59min:59sec then INDEFINITE, i.e. the oven operates continuously) or the **core probe temperature** (section "Further information: core probe" on page 19): each of these parameters reciprocally excludes the other. In the first case (time), the cooking cycle ends after the set time; in the second case (core probe), the cooking cycle ends when the set core temperature is reached.
- ② the **cooking temperature** (from 30°C to 260°C). For particularly delicate cooking cycles, the **Delta "T"** function can be used as an alternative (from 0°C to 120°C). In this case, you need to insert a core probe into the core of the food.  
By definition, the Delta "T" temperature = Oven cavity temperature minus Temperature measured by the core probe  
Example: if **Delta T = 80°C**, the cooking cycle ends when, for example, the temperature in the cavity reaches **150°C** and the core probe temperature reaches **70°C** (because 150°C-70°C = 80°C).
- ③ the **steam released into** (**STEAM.Maxi™**) or **removed from** (**DRY.Maxi™**) the oven cavity;
- ④ the **air flow speed: normal or pulsed** (left and right respectively; the fan turns off when the oven has reached the temperature).



fig. S6

### FURTHER INFORMATION: core probe

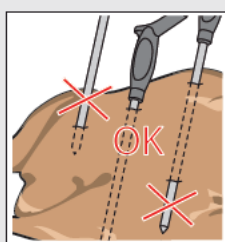

During the cooking cycle, the probe detects the temperature at the core of the product. It reaches the temperature set by the user when the product is perfectly cooked both on the surface and on the inside. The core probe must be inserted deep into the food being cooked. The probe head must reach the product's "core" i.e. the innermost portion without piercing its way through the other side. If the food you are cooking is relatively thin, insert the probe parallel to the oven tray. When dealing with several foods, insert the probe into the smallest product; when this has reached the required core temperature (and therefore cooking is stopped) take the product out of the oven, insert the probe into the smallest remaining piece and restart the cooking cycle.

- ⚠ Handle the probe with care because it is extremely sharp and, after use, the needle is very hot.
- ⚠ Extract the probe from the core of the food before removing the trays from the oven, and place it in the external probe holder (never leave it dangling inside/outside the oven cavity).
- ⚠ Before removing the tray, check that the probe cable is not in the way.

2C

SETTING SUBSEQUENT STEPS (IF NEEDED)

(fig. S7)

Once STEP 1 has been set, tap the > symbol once or more, if you want to set more STEPS. To set subsequent steps, repeat the procedure for setting STEP 1.

The top right of the window displays the STEP currently being set (e.g. step 2/1).

- ! Steps can be mixed (e.g. STEP 1 set to time and the other steps set with a CORE PROBE).
- ! To enable use, a cooking cycle must contain at least one STEP.
- ! Cooking does not necessarily require all nine steps: only set the STEPS which are required.
- ! The appliance automatically passes from one STEP to the next.

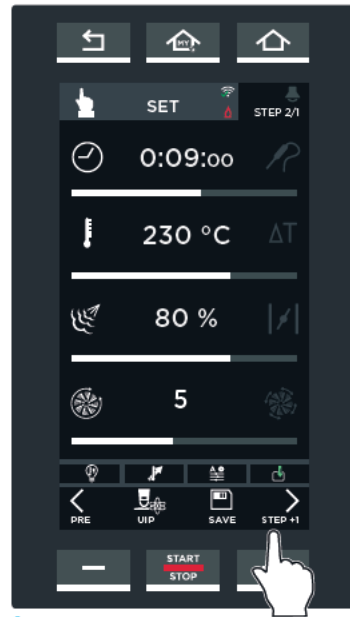

fig. S7

Notes

---

---

---

---

---

---

---

---

---

---

---

---

---

---

---

---

---

---

---

---

---

**2D CHOOSING WHETHER TO USE UIP TECHNOLOGY (UNOX INTELLIGENT PERFORMANCE)**

**How to activate the functions:**

- ① Tap the "UIP" icon (fig. S8).
- ② A screen listing all of the available functions (fig. S9) is shown.
- ③ Click on the name of the functions you want to activate/deactivate (in the example: the SMART.Preheating function is being deactivated). The name and corresponding icon at the bottom turn white to show that the function has been activated and can be used when needed for cooking/preheating cycles started in the future.
- green icon:** function is active
- red icon:** function is not active (e.g. AUTO SOFT).
- ④ Click on the green "Done" icon.
- ⑤ Click on the  button to display some brief information about the selected function.



fig. S8



fig. S9

The SMART.Preheating and ADAPTIVE.Cooking functions are always active by default, as we recommend that you use them.

**Display during cooking:**

During cooking, the icons at the bottom indicate the status of the function:

- A)** The function has NOT been activated; it will not be used to improve cooking/preheating
- B)** The function is active but is not currently in operation for this cooking/preheating cycle
- C)** The function is active and is currently in operation for this cooking/preheating cycle



**Making changes while cooking is in progress**

If, during a cooking cycle, you need to make any changes, for example you want to activate a function that is not active, follow the instructions shown in the figure below:



Click on the name of the functions you want to activate

**green icon:** active function

**red icon:** function not active (e.g. AUTO SOFT).

## FURTHER INFORMATION: UIP (UNOX INTELLIGENT PERFORMANCE)

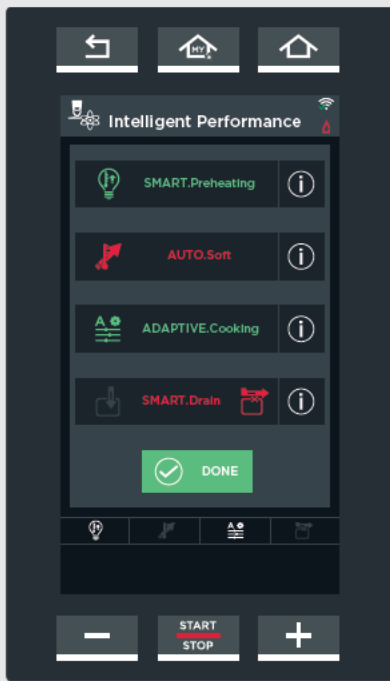

If selected, UIP technology allows you to **monitor** every preheating and cooking process constantly.

Thanks to this feature, the oven software is able to manage, where necessary, **changes** to the user settings **fully autonomously** without the operator needing to intervene. This guarantees a perfect cooking result every time.

### Available functions:

#### SMART.Preheating

This function automatically adjusts the time and temperature of the preheating cycle, to guarantee uniform cooking and energy efficiency.

#### AUTO.Soft

This function automatically adjusts the temperature increase speed to improve cooking evenness when cooking delicate foods

#### ADAPTIVE.Cooking

This function automatically optimises the cooking process parameters, according to the oven load, the time the door is open, and the readings from the oven sensors

#### SMART.Drain

This function associates the best position for the fat collection valve in the tank to the program. The program cannot be run if the valve is not positioned correctly. For information on managing the "Pollo" valve, please see the relevant manual.

If necessary, press the  button to show the function description on the display.

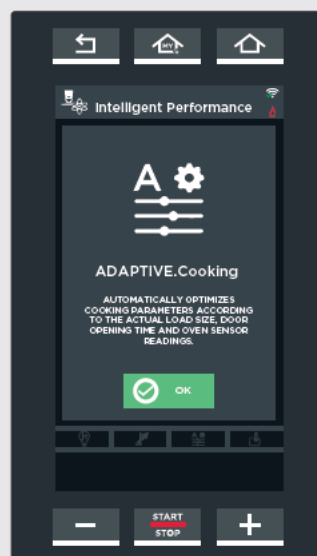
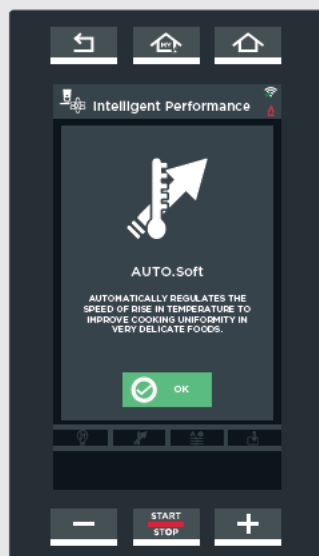
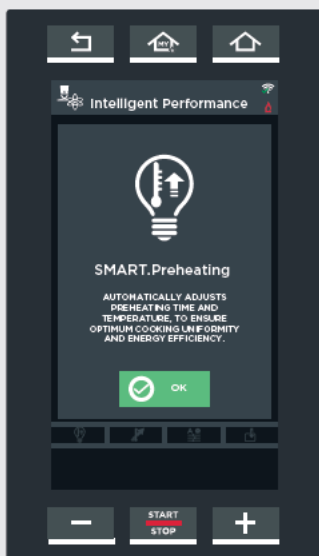

During a cooking cycle, the icons on the bottom part of the oven provide some useful information:

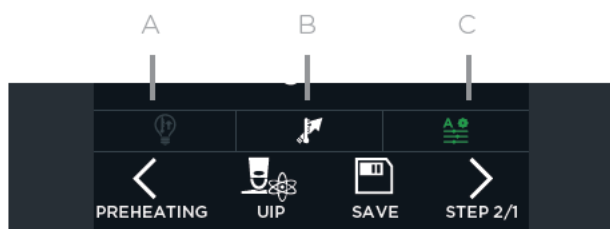

- A) The UIP function has NOT been activated (it will not be used to improve cooking)
- B) The UIP function is active but is not currently in use for this cooking cycle
- C) The UIP function is active and is currently in operation for this cooking cycle



### 3 STARTING A COOKING CYCLE

Press the "START/STOP" button to start a cooking cycle, according to the parameters set.

Three different displays may be shown on the screen:

- 3A preheating** (where applicable)

  - **standard** (UIP technology not used) or
  - **UIP** (UIP technology is used)

wait for this to end before putting the food in the oven;
- 3B cooling the cavity** (if the temperature in the cavity is higher than the set temperature e.g. because the oven has been operating continuously): wait for the end of this phase before putting the food in the oven;
- 3C cooking in progress**: in this case, it means that no preheating has been set, so you do not need to cool the oven. YOU must then put the food in the oven straight away.



#### 3A PREHEATING

If the cooking cycle includes a **standard preheating** step (without using UIP technology), screen **A** fig. S10 appears indicating:

- ① the elapsed time and the time remaining before the end of preheating (expected);
- ② the current temperature in the cavity and the temperature set for preheating;
- ③ that you can **change** the standard preheating cycle in progress with the one using UIP technology (see page 21)
- ④ the option to skip preheating;
- ⑤ the option of viewing/modifying the parameters in the subsequent steps.

When the set temperature is reached, a beep notifies the user that the preheating step has finished (if one has been set,  green icon \*) and screen **B** fig. S11 appears to indicate that the food should be put in the oven.

After, step 1 is started up automatically as soon as the oven door is closed.

-  \* Tap the  icon at the top right to change the colour:

  - green**= when the set temperature is reached, a beep notifies the user that the preheating step has finished
  - gray**= beep OFF

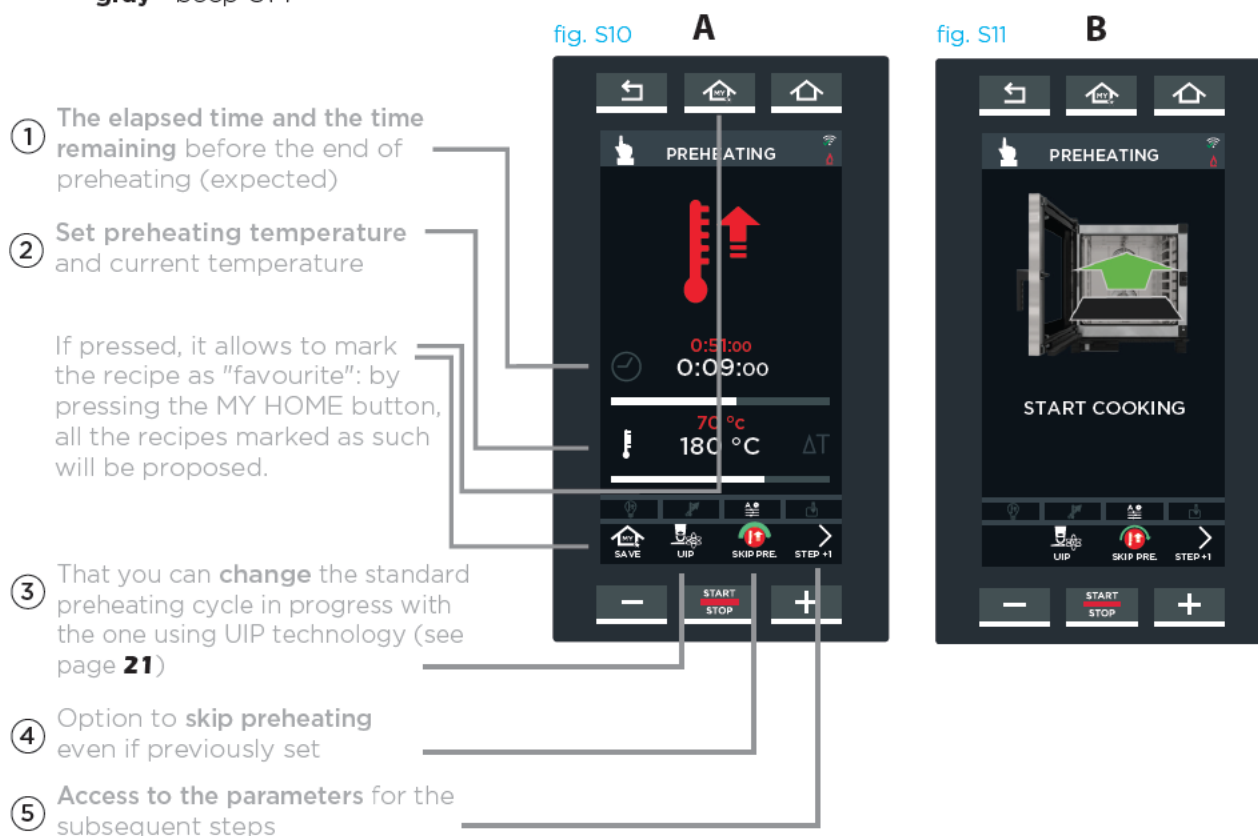

- 3A If the cooking cycle includes a **UIP preheating** step (using UIP technology), the following screen appears:
- A)** if the temperature in the cavity is below the temperature set for preheating
  - B)** if the temperature in the cavity is equal to or only slightly above the temperature set for preheating; in this case, the food can be put in the oven straight away.

fig. S12

The UIP preheating screen indicates:

- ① the elapsed time and the time remaining before the end of preheating (expected);
- ② the current temperature in the cavity and the temperature set for preheating;
- ③ that you can change the UIP technology preheating cycle in progress with the standard preheating cycle
- ④ the option of viewing/modifying the parameters in the subsequent STEPS.

When the set temperature is reached, a beep notifies the user that the preheating step has finished (if one has been set,  green icon \*) and screen **B)** fig. S13 appears to indicate that the food should be put in the oven.

After, step 1 is started up automatically as soon as the oven door is closed.

- ! \* Tap the  icon at the top right to change the colour:
- green**= when the set temperature is reached, a beep notifies the user that the preheating step has finished
  - gray**= beep OFF

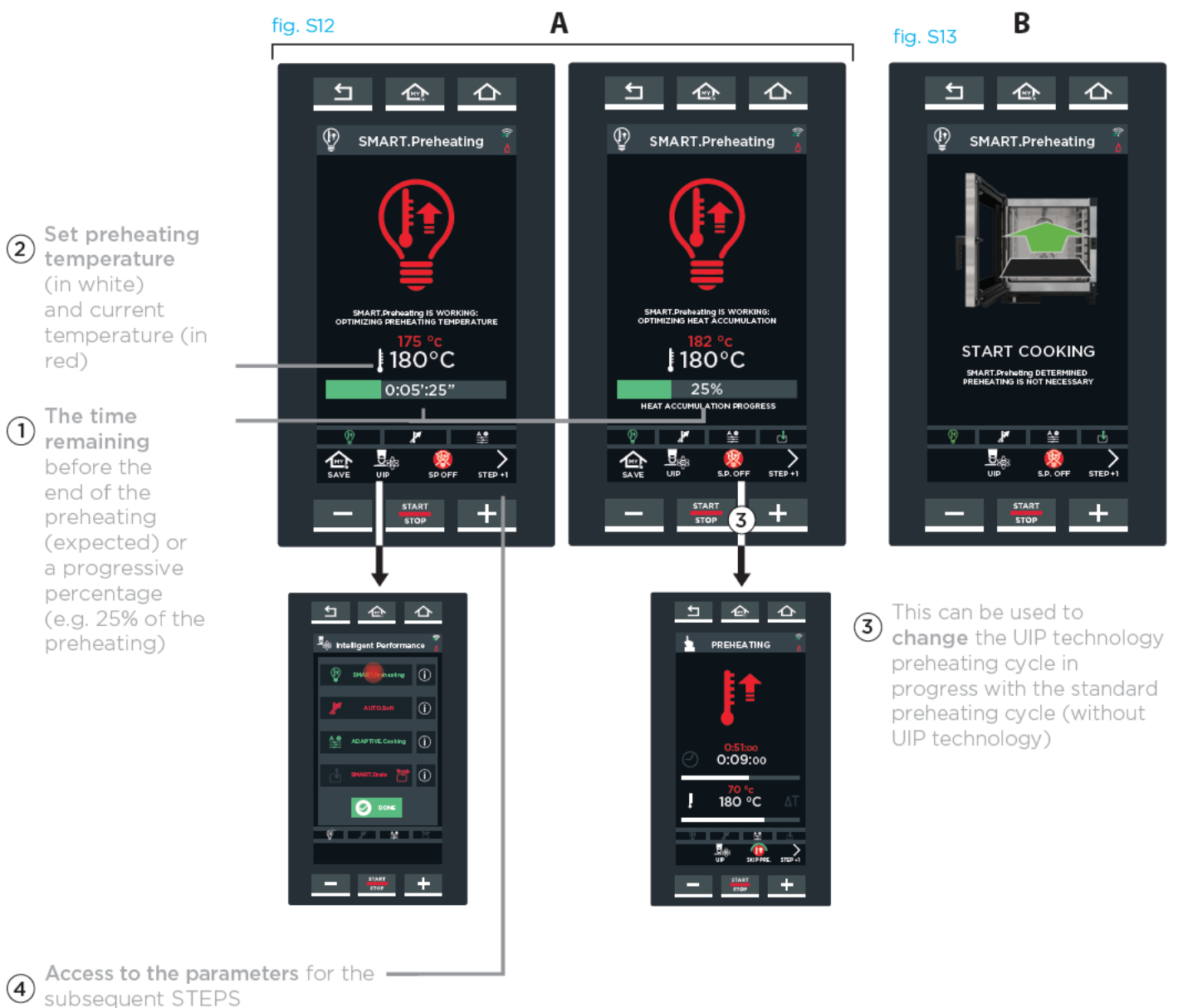

3B

**COOLING**

If, at the start of cooking, the temperature measured in the cavity is higher than the set temperature (e.g. because the oven operates continuously), the [fig. S14](#) screen appears.

It indicates that the oven is cooling the cooking cavity. Always wait for this phase to end, without putting any food in the oven.

When the cavity has cooled, the cooking cycle will start automatically.

Set preheating temperature (in white) and current temperature (in red)

Time remaining until the end of cooling (estimated)



fig. S14

! If you want to stop the cooking cycle in progress, hold down the “START/STOP” button (approximately 4-5 seconds).

**FURTHER INFORMATION: measuring consumption**



From the cooking end screen, click on the  button to display the electricity and water consumption data, as well as the HACCP data.

**FURTHER INFORMATION: screen locking**



If the oven door is opened, the screen on the side warns that it is not possible to use the display for safety reasons. When the door is closed, the screen is operational again.

! If the door remains open for a long time, the display unlocks automatically after a specific time set by the operator. [section “Further information: core probe” on page 19](#)

3C

### COOKING IN PROGRESS

During the cooking cycle, various screens **are displayed** according to how the cooking steps have been set (by time or using the core probe).

! The end of each step and **automatic** progression to the next step, if set, is indicated by a short beep (if activated).

The screen **fig. S15A** is displayed if all of the steps have been set with a **duration**.

The screen displays:

- ① the current step in progress;
- ② the remaining time until the end of the cooking cycle/step;
- ③ the time the food will be ready;
- ④ the option to modify the parameters once a cooking cycle has already been started or to stop the current cooking cycle by reducing the duration to "00:00:00".

### COOKING CYCLES WITH STEPS SET TO TIME

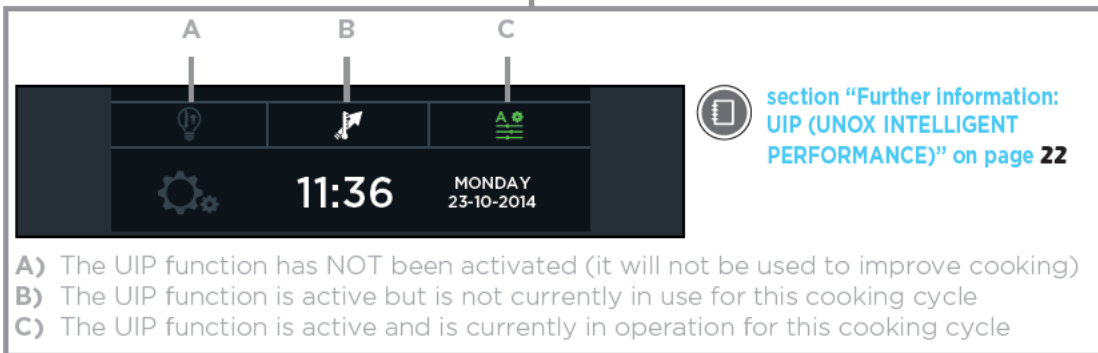
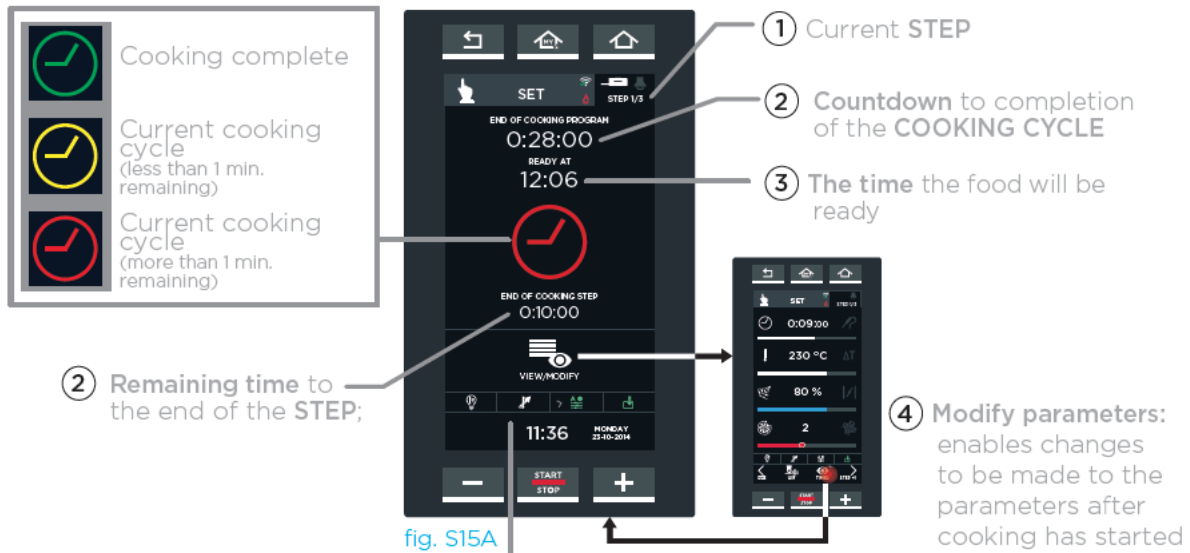

! If you want to stop the cooking cycle in progress, hold down the "START/STOP" button (approximately 4-5 seconds).

The screen **fig. S15B** is displayed if all of the steps have been set using the **core probe** method.

The screen displays:

- ① the current STEP in progress;
- ② the remaining time until the end of the cooking cycle/step;
- ③ the time the food will be ready;
- ④ the option to modify the parameters once a cooking cycle has already been started or to stop the current cooking cycle by reducing the duration to “00:00:00”;
- ⑤ the temperature detected by the core probe (red) and the set temperature (white);

### COOKING CYCLES WITH STEPS SET USING A CORE PROBE

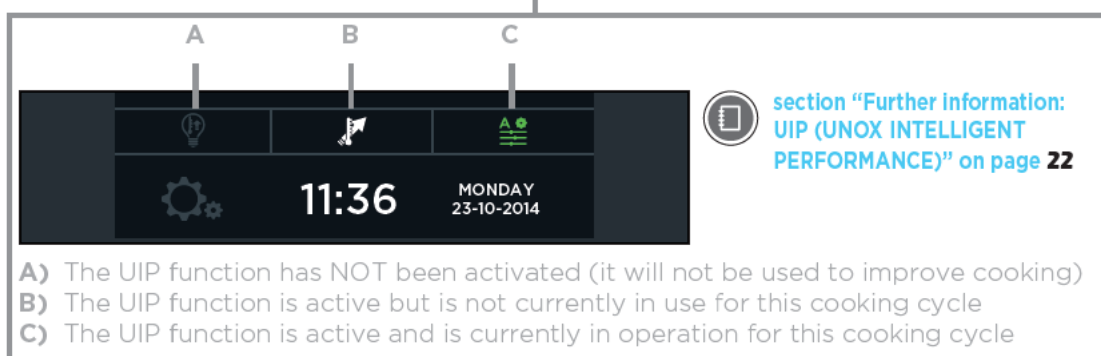
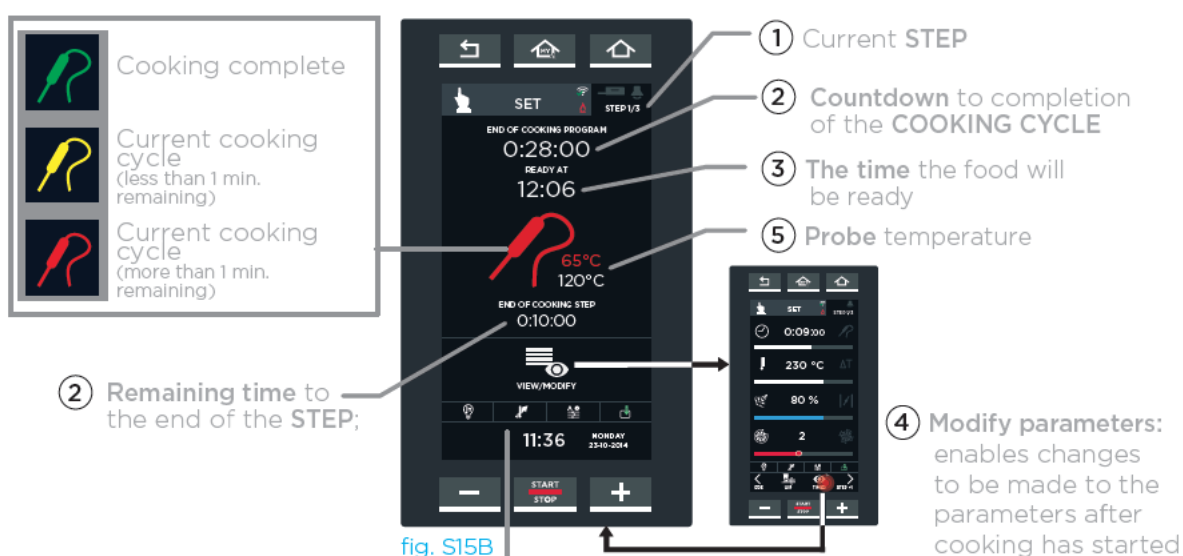

- ! If you want to stop the cooking cycle in progress, hold down the “START/STOP” button (approximately 4-5 seconds).



## 4 COOKING END

Cooking ends when the set time interval or core probe temperature is reached; the end of cooking is indicated by a long beep and the relevant screen showing to the side (fig. 16).

This screen allows the user to:

- ① save the completed cooking cycle ;
- ② repeat this completed cooking cycle keeping the same parameters;
- ③ repeat the last step of the cycle, modifying the duration;
- ④ repeat the last step of the cycle after moving the core probe to another portion;
- ⑤ repeat the last set step, modifying the core probe temperature.

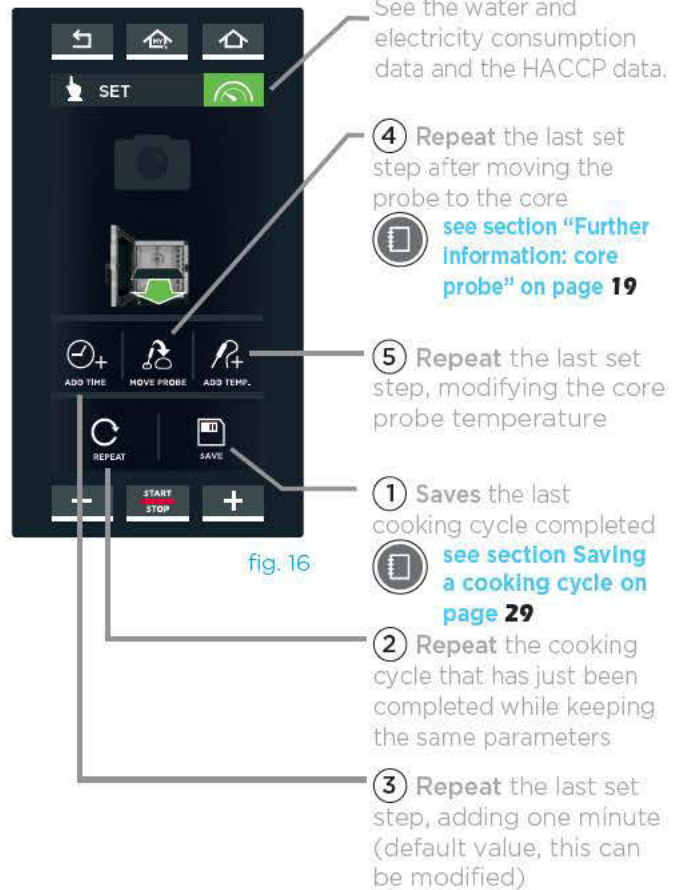

! If you do not want to save the cooking cycle, press "HOME" to return to the main page.





## 5 SAVING A COOKING CYCLE

Saving a recipe means that it can be used again at any time, without having to reset the parameters.

The recipe can be saved after entering the cooking parameters (time, temperature, etc.) or at the end of cooking, by tapping the “SAVE” button in both scenarios.

If an UNOX INTELLIGENCE PERFORMANCE (UIP) technology function was used for the recipe, the selections made are saved in the memory.

To recall the saved cooking cycles, see section “PROGRAMS”

For further details see “Programs menu” on page 32.

By tapping the various symbols on the display, **fig. 17** the user can:

- ① assign a recipe name and confirm with “OK”, (e.g. MERINGUES) (see **fig. S18**);
- ② assign a photo to the recipe, selecting one from those available (see **fig. S19**);
- ③ assign a tray to the recipe, selecting from those available (see **fig. S20**);
- ④ save a cooking cycle with the set parameters (name, photo, etc.).

At the end of these settings, the **fig. S21** screen is displayed.

The “SAVE” button opens the **fig. S22** screen: tap the position where the cooking cycle is to be saved (e.g. under “BEIGNET”). If you select a slot that is already occupied, the program requests authorisation to overwrite the program.

At the bottom of the screen, the arrows and are used to scroll through the 16 positions available in the group, while the arrows and scroll through the 16 groups available.

The cooking cycle will be saved with the entered settings (**fig. S23**).

Tap one of the cooking cycles listed (**fig. S23**) to open the **fig. S24** screen that enables you to:

- (A) view/modify the saved cooking cycle;
- (B) duplicate the cooking cycle (to create one with similar parameters);
- (C) delete a saved cooking cycle: in this case the system requests confirmation before permanently deleting the item (**fig. S25**).
- (D) start the cooking cycle by pressing the “START/STOP” button.

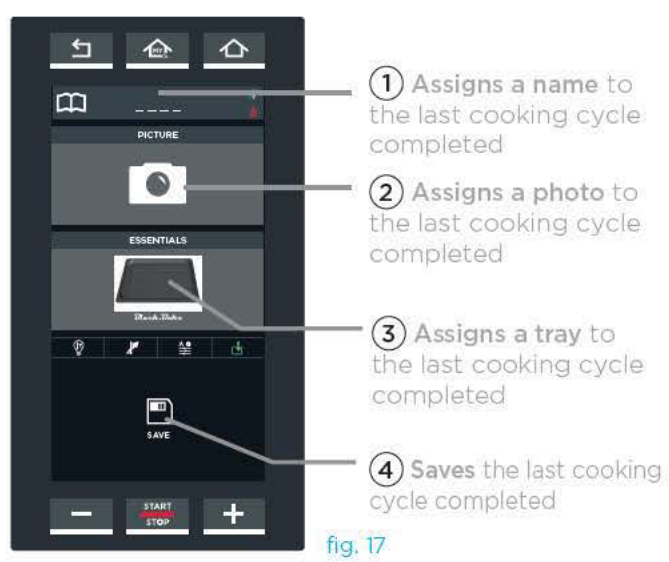

fig. S18



fig. S19



fig. S20



fig. S21

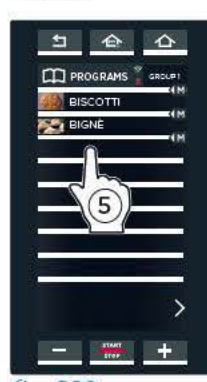

fig. S22



fig. S23



fig. S24



fig. S25



## MIND.Maps Menu

A new simple, quick and intuitive way to set cooking parameters.

This menu allows you to set a parametric curve that controls the temperature, steam extraction/introduction and the airflow speed in the cavity at all times.

⚠ Only the stylus supplied can be used to set this curve.

### HOW MIND MAPS WORKS

In the example **fig. MM2**, a MIND.Maps screen is shown. The vertical **axis (Y)** shows the parameters to be set (e.g. temperature, steam input or extraction, airflow speed, etc.), while the **horizontal axis (X)** shows the ⌚ time or 🌡 core probe temperature.

By drawing a curve with the stylus you can modify a parameter (e.g. temperature) over time, minute by minute, giving you maximum flexibility and control.

Example **fig. MM2** shows the temperature being set based on the time:

- at 5 minutes, the temperature is set to 230°C,
- at 15 minutes the temperature should decrease to 135°C and so on.

🔧 You can also choose to use the UNOX INTELLIGENT PERFORMANCE (UIP) technology by clicking on the relevant symbol.

📖 **section "UIP (UNOX INTELLIGENT PERFORMANCE)" on page 12**

### HOW TO DRAW A MIND.MAPS CURVE

- 1 Tap the icon "NEW MIND MAP" (**fig. MM1**).
- 2 Use the stylus to draw the required curve (**fig. MM2**). The symbol > enables access to curve settings at over 25 minutes.

#### Changes to the curve

- 3 To **change** a part of a curve that has already been drawn, click on the curve with the stylus and, while continuing to hold it, modify the curve as desired.
- 4 To **delete** parts of a curve that has already been drawn, repeatedly click on the red "X" on the left.

#### Inserting guide rulers

- 5 To **insert rulers** that help view the values, click on the X axis in the desired position (in the example: 5 and 15 minutes): the numbers will be highlighted in grey and a green ruler will appear. The numbers above the rulers (in the example "10") show the difference in minutes compared to the previous ruler (15 minus 5 minutes = 10).
- 6 To **delete rulers**, with the numbers highlighted in grey, repeatedly click on the red "X" on the left: the rulers will be deleted in the order they were created.

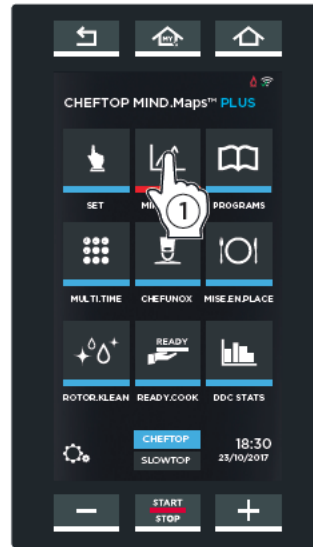

fig. MM1

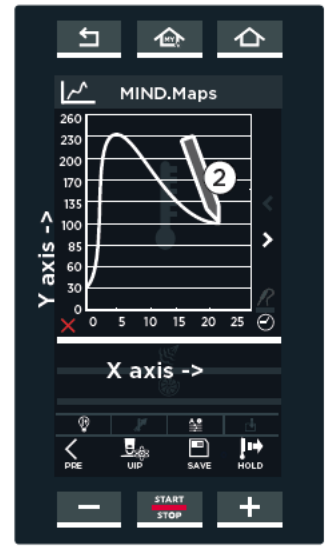

fig. MM2

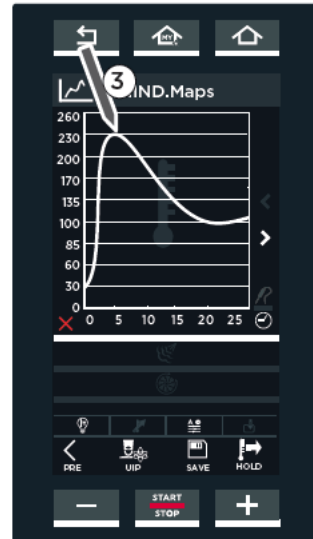

fig. MM3



fig. MM4

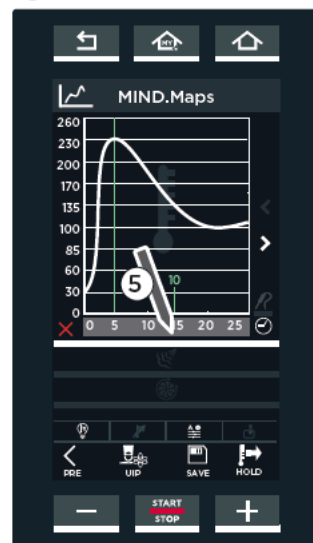

fig. MM5

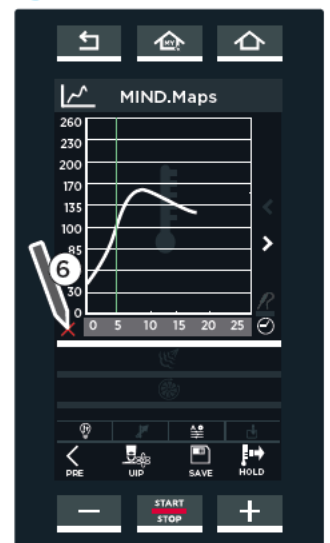

fig. MM6

**ZOOM**

⑦ To **enlarge** an interval, click on the Y axis in the desired position (in the example: an interval between 170° and 200°).

⑧ Click in the Y axis again or on the symbol in the bottom left corner to return to the normal mode.

**SUBSEQUENT PARAMETERS AND SAVING THE CURVE**

⑨ Tap another icon to set the next parameters, steam extraction or input, and airflow speed.

⑩ Trace a new curve to set the selected parameter:

! steam extraction or input: the extraction values are displayed in RED, while the input values are displayed in BLUE;

! airflow speed (from speed 1 - minimum, to speed 4 - maximum): the pulsating fan speed is shown with a dashed line (values below zero), the normal speed is shown with a continuous line (values above zero). The thickness of the line also indicates the speed (a thin line shows a slow speed and a thick line shows a high speed).

⑪ To set preheating, press the “PREHEATING” button at the bottom right and set this step.

📖 see section Preheating settings on page 18

⑫ Press the “SAVE” button to save the set curve; the saving process is the same as that explained previously under “SET MENU”.

📖 see section Saving a cooking cycle on page 29

! The “HOLD” button at the bottom right means the oven can be used continuously.

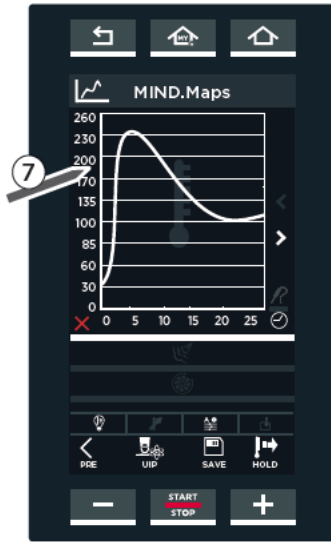

fig. MM7

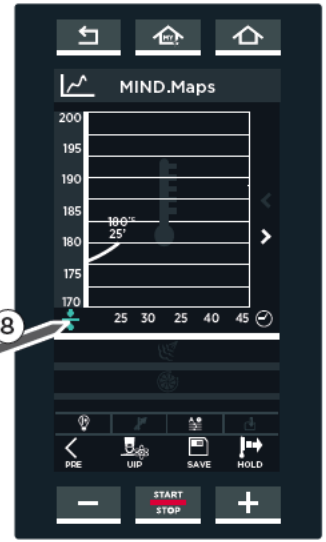

fig. MM8

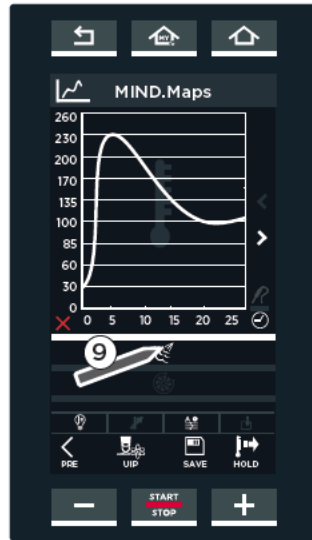

fig. MM9

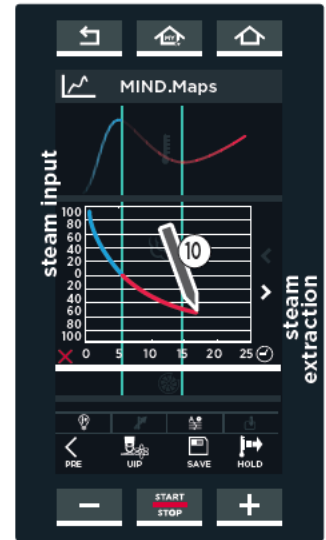

fig. MM10: steam extraction/input

**START THE COOKING CYCLE SET**

Press the “START/STOP” button: if a **preheating** cycle has been set for the cooking cycle, the screens shown on page 23 (standard preheating) and 24 (SMART.Preheating preheating with UIP technology) will appear.

When the set temperature is reached, a beep notifies the user that the preheating step has finished (if one has been set, 🟢 green icon \*) and an icon appears to indicate that the food should be put in the oven. After, step 1 is started up automatically as soon as the oven door is closed.

! \* Tap the 🟢 icon at the top right to change the colour:

**green**= when the set temperature is reached, a beep notifies the user that the preheating step has finished

**gray**= beep OFF

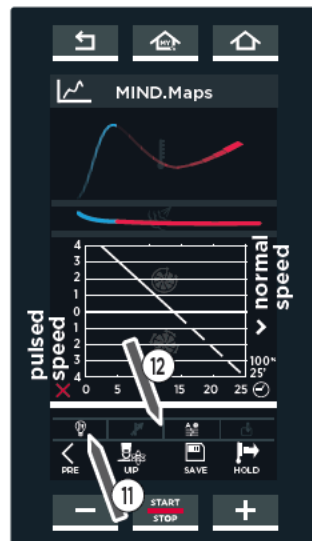

fig. MM11: airflow speed, preheating and saving recipes

HOLD: the oven operates continuously





## Programs menu

This menu enables access to a list of cooking cycles saved previously.

### 1 MY PROGRAMS

In this section the user can recall a previously saved cooking cycle by using the “SET MENU”.

see section [Saving a cooking cycle on page 29](#)

① Tap the “PROGRAMS” icon ([fig. P1](#));

② tap the “MY PROGRAMS” icon ([fig. P2](#)): a list of cooking cycles previously saved using the “SET MENU” ([fig. P3](#)) opens.

At the bottom of the screen, the arrows and are used to scroll through the various cooking cycles saved in the group, while arrows and are used for scrolling through the 16 groups available.

③ Tap one of the cooking cycles listed ([fig. P3](#)) to open the [fig. P4](#) screen that enables you to:

- view/modify the saved cooking cycle;
- duplicate the cooking cycle (to create one with similar parameters);
- delete a saved cooking cycle: in this case the system requests confirmation before permanently deleting the item ([fig. P5](#)).

④ To start the cooking cycle, press the “START/STOP” ([fig. P4](#)).

The following will then start automatically:  
**standard or UIP preheating (where relevant):** wait for this to end before putting the food in the oven

see section [23 - 24](#)

**cooling the cavity** (if the temperature in the cavity is higher than the set temperature e.g. because the oven has been operating continuously): wait for the end of this phase before putting the food in the oven;

see [page 25](#)

**cooking** with the parameters that have just been set: in this case, it means that no preheating has been set, so you need to put the food in the oven straight away. When completed, a screen will prompt the user to change or repeat the recipe ([fig. P6](#)).



fig. P1



fig. P2



fig. P3



fig. P4



fig. P5



fig. P6

Repeat the last step after moving the probe to the core

see section [“Further information: core probe” on page 19](#)

Repeat the last set step, modifying the core probe temperature

Repeat the cooking cycle that has just been completed keeping the same parameters

Repeat the last set step, adding one minute (default value, this can be modified)

## 2 MY MIND.MAPS

① In this section the user can recall a previously saved cooking cycle by using the “MIND.MAPS MENU”.

📖 see section MIND.Maps Menu on page 30

② To access the list of saved cooking cycles, touch the “PROGRAMS” icon (fig. P7) followed by the “MY.MIND.MAPS” icon (fig. P8): this opens a list of all previously saved cooking cycles (fig. P9).

⚠ At the bottom of the screen, the arrows < and > are used to scroll through the various cooking cycles saved in the group, while arrows ∨ and ∧ are used for scrolling through the 16 groups available.

③, ④ and ⑤: see previous page



fig. P7



fig. P8



fig. P9





## MultiTime menu

In the modern kitchen, needing to cook foods with different cooking times but in the same conditions (temperature, steam, etc.) simultaneously is not uncommon. With the “Multi.time” menu you can use the oven in a continuous cycle and set up to 10 timers that notify you when each dish is ready.

### EXAMPLE OF OPERATION

Using this function, the oven maintains the set temperature and humidity set indefinitely.

The example to the side shows that 3 trays containing different foods are inserted into the oven cavity at 10:00 (➡).

For each tray, a timer is set with a different end time, as each foodstuff requires a specific cooking time (🕒 30 minutes, 45 minutes, 2 hours).

⚠ We recommended using timer 1 for the tray at the top of the oven, timer 2 for the tray below and so on. This helps the user to know which tray needs to be taken out when the timer expires (for example, when timer 2 expires, take out the second tray down).

When a timer expires (in the example the first timer to expire will be the one for tray 2, ➡ at 10:45), a beep notifies the user that the corresponding tray needs to be taken out. When the door is opened and closed, the expired timer is reset.

A maximum of 10 timers can be set (corresponding to a maximum of 10 different foods being cooked at the same time).

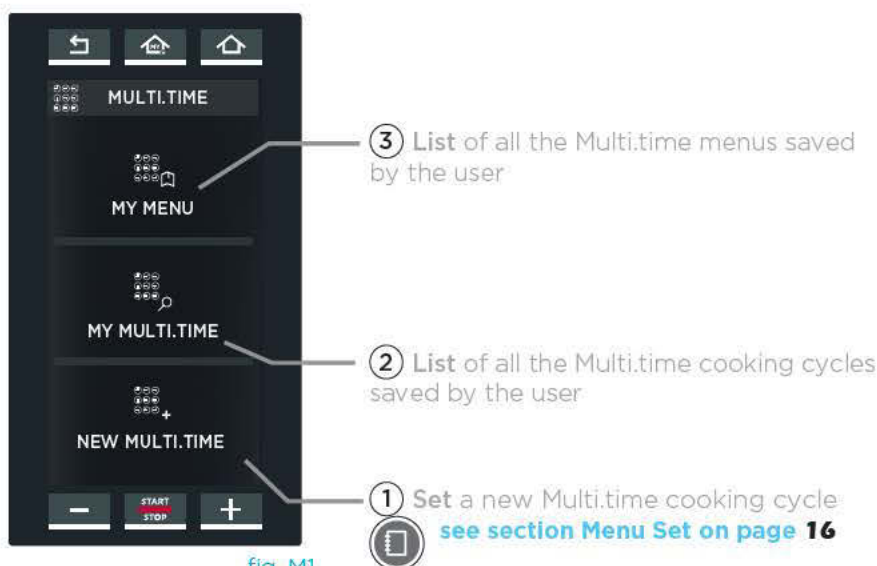
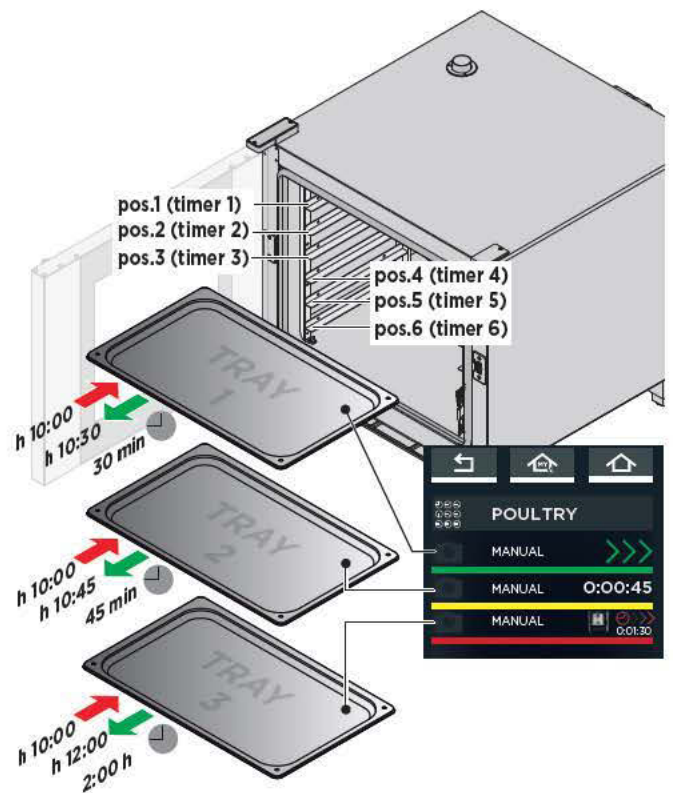

fig. M1

# 1 NEW MULTI.TIME: SET AND SAVE A NEW MULTI.TIME COOKING CYCLE

This section allows the user to create, start and save a new Multi.time recipe.

## 1A SETTING THE PARAMETERS (fig. M3)

The parameters are set in the same way as explained in the "SET MENU" section (For more information see section Preheating settings on page 18 and Menu Set on page 16).

- ! The cooking cycle does NOT include:
  - cooking steps;
  - entering a time (cooking is "indefinite").
- ! Each cooking cycle includes preheating which is set by touching the arrow

You can also choose to use the UNOX INTELLIGENT PERFORMANCE (UIP) technology by clicking on the relevant symbol.

section "UIP (UNOX INTELLIGENT PERFORMANCE)" on page 12



fig. M2

fig. M3

The SAVE button saves the recipe with the parameters set: this enables you to reuse it countless times.



fig. M4

fig. M5

## 1B SAVING THE SET PARAMETERS (OPTIONAL) (fig. M3)

If you want to save the cooking cycle, press the "SAVE" button (it is saved in the same way as explained in the "SET MENU" section).

For further details, see section Saving a cooking cycle on page 29.

Saving a recipe allows you to reuse it time and time again, without needing to reset the parameters each time (temperature, steam, fan speed, etc.). Each time the recipe is launched, you need to set the relevant timers (up to 10): if you want to save these timers, you need to create a menu: for more information, see section Further information: "NEW MENU" function on page 39.

## 1C STARTING A COOKING CYCLE (fig. M3)

Tap the "START/STOP" button from the parameter setting window or by selecting from a list if previously saved, (fig. M4): in this case, the fig. M5 screen will appear, which enables you to:

- 1 view/modify the saved cooking cycle;
- 2 duplicate the cooking cycle (to create one with similar parameters);
- 3 delete a saved cooking cycle: in this case the system requests confirmation before permanently deleting the item;
- 4 create a new menu (see section Further information: "NEW MENU" function on page 39);
- 5 start the cooking cycle by pressing the "START/STOP" button.

After pressing the "START/STOP" button, if a preheating cycle has been set, the screens shown on page 23 (standard preheating) and 24 (SMART.Preheating preheating with UIP technology) will appear.

When the set temperature is reached, a beep notifies the user that the preheating step has finished (if one has been set, green icon \*) and an icon appears to indicate that the food should be put in the oven.

After, step 1 is started up automatically as soon as the oven door is closed.

- ! \* Tap the green icon at the top right to change the colour:
  - green= when the set temperature is reached, a beep notifies the user that the preheating step has finished
  - gray= beep OFF

## 1D SETTING THE TIMERS

After the food has been placed in the oven and the door has been closed, set the timers for the different trays.

We recommended using timer 1 for the tray at the top of the oven, timer 2 for the tray below and so on. This helps the user to know which tray needs to be taken out when the timer expires (for example, when timer 2 expires, take out the second tray down).

- 1 Tap the symbol "+" on the screen (fig. M8). A screen will open (fig. M9) corresponding to the first timer: this can be set to time, using the core probe or by selecting a similar cooking cycle.

### Setting a timer

- 2 tap the hours, minutes or seconds field;
- 3 drag the slider or use the buttons **-** **+** to set the required value;
- 4 confirm by pressing the "START/STOP" button (fig. M10).

Timer expires based on the time set (in the example: 15 minutes).

### Setting a timer with a core probe

- 2 tap the "core probe" icon, on the right.
- 3 drag the slider or use the buttons **-** **+** to set the required value;
- 4 confirm by pressing the "START/STOP" button (fig. M10).

Only 1 timer with a core probe can be set. The timer will expire when the set core-probe temperature is reached.

### Setting the timer with a similar recipe

The oven suggests recipes which have been set with the "SET" MENU and saved in the "PROGRAMS" MENU. These have identical temperature and humidity settings in the oven cavity (in the example: "VEGETABLES"). Tap the desired recipe to select it. The timer expires based on the time set for the selected recipe (in the example: 20 minutes). Proceed in the same way for each tray placed in the oven (up to a maximum of 10 simultaneous timers).

-  To delete a timer from the list, tap the row of the timer you want to delete and hold for at least 3 seconds.

### Exiting the function

-  If you want to exit the function and, therefore, stop the oven operating indefinitely, hold down the "START/STOP" button (approximately 4-5 seconds).

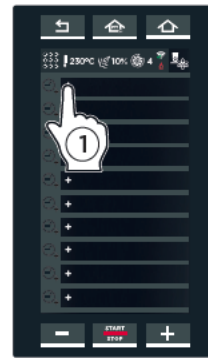

fig. M8

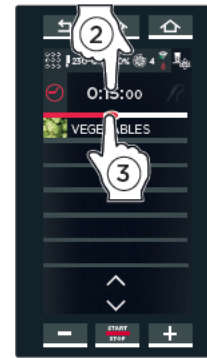

fig. M9

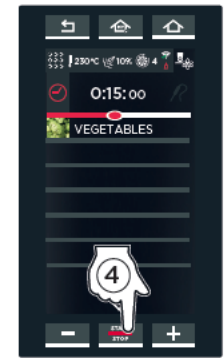

fig. M10

Multi.time recipe "BROCCOLI" set at point A:  
Temp.: 120°C  
Humidity: 40%

"VEGETABLES" recipe previously set with the SET menu:  
Duration: 20 minutes  
Temp.: 120°C  
Humidity: 40%



1E The screen at the side shows a possible cooking cycle scenario in progress.

There are 7 set timers.

Some are set by entering a **TIME** (MANUAL - for example, the first, 12:51), others are set by entering a **CORE PROBE TEMPERATURE** (MANUAL - for example, the fourth, 90°C), and others by using a **RECIPE** which was saved previously ("VEGETABLES").

! The colour indicates:

- **GREEN:** timer expired (the food is ready). A beep notifies the user that it is time to take the tray out of the oven. When the door is closed, the timer will disappear from the list.
- **YELLOW:** timer about to expire (the food is almost ready). Prepare to take the tray out of the oven.
- **RED:** timer in operation (dishes still cooking). The time remaining or the temperature to be reached are indicated on the right.

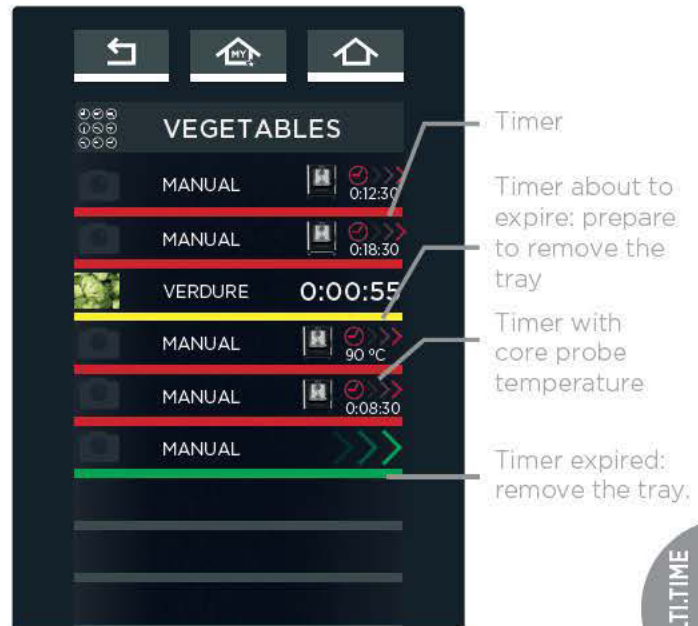

fig. M11

## 2 MY MULTI.TIME

In this section, the user can call up a previously saved cooking cycle by using the "NEW MULTI.TIME" menu.

2A To access the list of saved cooking cycles, tap the icon "MY MULTI.TIME" (fig. M12): this opens a list of all previously saved cooking cycles (fig. M13).

! At the bottom of the screen, the arrows < and > are used to scroll through the various cooking cycles saved in the group, while arrows v and ^ are used for scrolling through the 16 groups available.

2B Tap one of the cooking cycles listed (fig. M13) to open the fig. M14 screen that enables you to:

- ① view/modify the saved cooking cycle;
- ② duplicate the cooking cycle (to create one with similar parameters);
- ③ delete a saved cooking cycle: in this case the system requests confirmation before permanently deleting the item.
- ④ create a new menu (new menu);

! For further information, see section Further information: "NEW MENU" function on page 39

⑤ start the cooking cycle by pressing the "START/STOP" button (fig. M14).

2C After the food has been placed in the oven and the door has been closed, set the timers for the different trays (see page 36 - fig. M8, fig. M9, fig. M10)



fig. M12



fig. M13







fig. M14

### 3 MY MENU

In this section the user can recall a previously saved menu by using the "NEW MENU" function.

 For further information, see section Further information: "NEW MENU" function on page 39

To access the list of saved cooking cycles, tap the "MY MENU" icon (fig. M1). This opens a list of all previously saved cooking cycles (fig. M15).

 At the bottom of the screen, the arrows  and  are used to scroll through the various cooking cycles saved in the group, while arrows  and  are used for scrolling through the 16 groups available.

Tap one of the cooking cycles listed (fig. M15) to open the fig. M16 screen that enables you to:

- ① view/modify the saved cooking cycle;
- ② duplicate the cooking cycle (to create one with similar parameters);
- ③ delete a saved cooking cycle: in this case the system requests confirmation before permanently deleting the item.
- ④ start the cooking cycle by pressing the "START/STOP" button.



fig. M15



fig. M16



## FURTHER INFORMATION: "NEW MENU" function

The "NEW MENU" function allows up to 10 timers to be set; these time or temperature values can also be saved.

The trays can be taken out of the oven as the dishes are ready, according to the timers set.

To set the function:

- ① call up a recipe saved in the "MY MULTITIME" MENU (in the example, "POTATOES");
- ② tap the "NEW MENU" icon;
- ③ set the timers (as explained in point ① on page 45) on the basis of the number of trays to be used. The timers are all white showing they are waiting.
- ④ When all the required timers have been set, press the "START/STOP" button on the page that shows all of the timers.
- ⑤ Press "SAVE";
- ⑥ Select where you want to save the menu.

After, to call up and start a cooking cycle, click on the "MY MENU" MENU, select the recipe by tapping it and start it using the "START/STOP" button.

 For further information, see section "MY MENU" on page 38



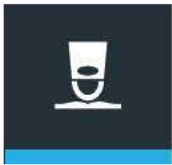

## ChefUnox menu

FOR "PLUS" MODELS ONLY This menu displays a series of default recipes set by UNOX.

**1 CHEFUNOX MULTI.TIME**  
In this section, you can see the Multi.time programs preset by UNOX.

 You can also choose to use the UNOX INTELLIGENT PERFORMANCE (UIP) technology by clicking on the relevant symbol.

 section "UIP (UNOX INTELLIGENT PERFORMANCE)" on page 12

**1A** **1** Tap the "CHEFUNOX" icon and select the section "CHEFUNOX MULTI.TIME" (fig. MT1);  
**2** select a Multi.Time program (for example, "GRILL").

PREHEATING begins, the screen **3** appears showing:

- the current oven cavity temperature;
- the set preheating temperature;
- the option to skip preheating (SKIP PREHEATING).

When the set temperature is reached, a beep notifies you that the preheating step has finished.

**1B** Once the pre-heating phase has finished, **set the timers** based on the number of trays to be cooked.

- 4** Tap the symbol "+" on the screen.
- 5** The screen relative to the first timer opens: this can be set:
  - to time or using a core probe (in the example: 0:10:00),
  - selecting one of the compatible user recipes (in the example: burgers),
  - selecting a recipe that has been preset by UNOX.

### SETTING A TIMER

- tap the hours, minutes or seconds field;
- drag the slider or use the buttons **-** **+** to set the required value;
- confirm by pressing the "START/STOP" button. The timer expires based on the time set.

### SETTING A TIMER WITH A CORE PROBE

- tap the "core probe" icon, on the right.
- drag the slider or use the buttons **-** **+** to set the required value;
- confirm by pressing the "START/STOP" button. Only 1 timer with a core probe can be set. The timer will expire when the set core probe temperature is reached.

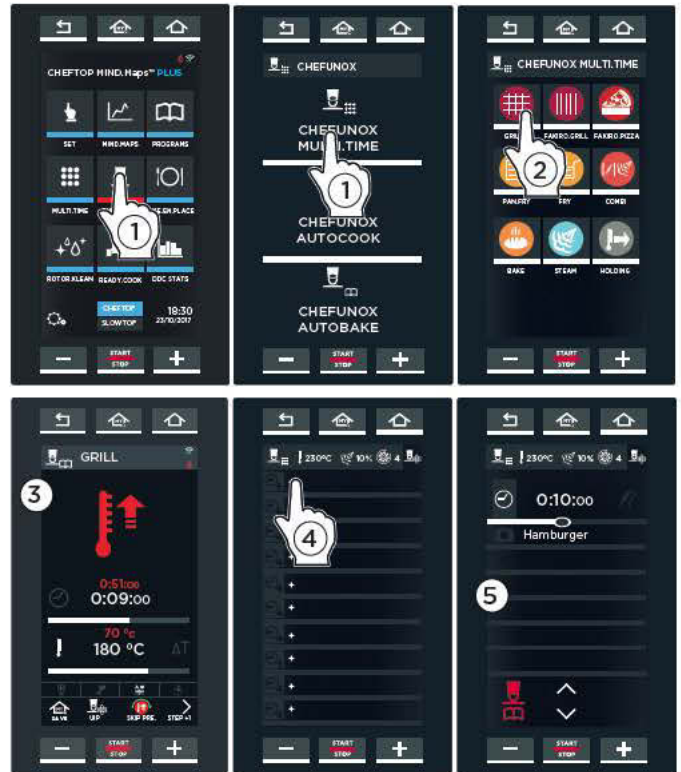

fig. MT1

GRILL: grilling foods

FAKIRO. GRILL: grilling meat, fish and vegetables on the FAKIRO™

Grill trays

FAKIRO.PIZZA: baking pizza and focaccia bread

PAN.FRY: cooking breaded vegetables, meats and fish on Pan Fry trays

FRY: cooking chips/fries

COMBI: convection and steam cooking

BAKE: baking pastry and bread

STEAM: steam cooking

HOLDING: keeping products warm





## SETTING THE TIMER WITH A COMPATIBLE USER RECIPE

The oven proposes **USER RECIPES**, saved previously with parameters compatible with the type of program selected (e.g. **burgers**). In this case, the timer is based on the time set for the selected recipe.

## SETTING THE TIMER WITH A PRESET UNOX RECIPE

The oven proposes **PRESET "CHEFUNOX" RECIPES**. In this case, the timer is based on the time set for the selected recipe.

! The names of the recipes in the screens shown here may differ from those for your oven, as they are examples only.

- 6 Tap the icon shown in the figure.
- 7 Select the type of food to be grilled (e.g. **BEEF**).
- 8 Select the desired category (e.g. **STEAK**).
- 9 Based on the selected recipe, the oven offers various screens to customise the cooking cycle:
  - temperature
  - weight
  - thickness
  - internal degree of cooking: **RARE - MEDIUM - WELL DONE**
  - external degree of cooking: **LIGHT - MEDIUM - BROWN**. The internal and external degree of cooking can also be set by dragging the cursor to the desired temperature.
- 10 By pressing the "START" button, the cooking cycle will appear on the Multi.time screen. Proceed in the same way for each tray placed in the oven (up to a maximum of 10 simultaneous timers).

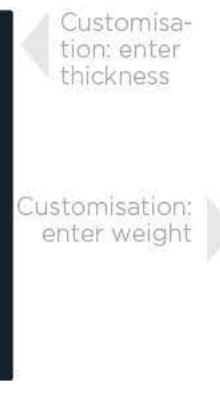
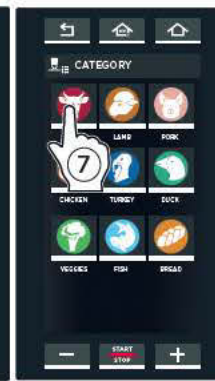
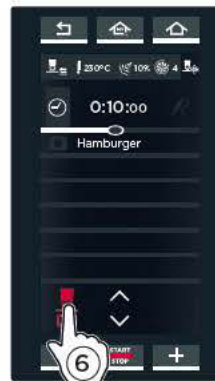
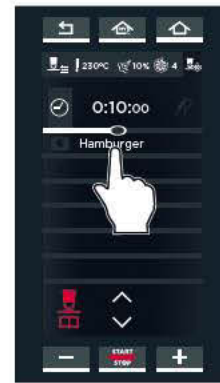

Customisation: enter thickness

Customisation: enter weight

- 10 The screen at the side shows a possible cooking cycle scenario in progress. There are 4 set timers. Some are set by inserting a **TIME** (MANUAL - e.g. **20 and 11 minutes**), others have been set by using a **USER RECIPE** (e.g. **"BURGER"**), and others have been set by using a **PRESET "CHEFUNOX" recipe** (e.g. **"STEAK"**).

! The colour indicates:

- **GREEN**: timer expired (the food is ready). A beep notifies the user that it is time to take the tray out of the oven. When the door is closed, the timer will disappear from the list.
- **YELLOW**: timer about to expire (the food is almost ready). Prepare to take the tray out of the oven.
- **RED**: timer in operation (dishes still cooking). The time remaining or the temperature to be reached are indicated on the right.



Timer with preset CHEFUNOX recipes: time elapsed, remove the tray.

Timer: time almost elapsed, prepare to take the tray out of the oven

Timer with user recipe still being cooked

2

**CHEFUNOX AUTOCOOK/AUTOBAKE**

In this section, you can see the “CHEFUNOX AUTOCOOK” programs and the “CHEFUNOX AUTOBAKE” programs preset by UNOX.

! The names of the recipes in the screens shown here may differ from those for your oven, as they are examples only.

- 1 Tap the icon “CHEFUNOX” and select the section “CHEFUNOX AUTOCOOK/AUTOBAKE”;
- 2 select a program (for example “GRILL”).
- 3 Select the type of food to be grilled (e.g. VEGETABLES).
- 4 Select the desired category (e.g. COURGETTES).
- 5 Based on the selected recipe, the oven offers various screens to customise the cooking cycle:
  - weight
  - thickness
  - internal degree of cooking: RARE - MEDIUM - WELL DONE.
  - external degree of cooking: LIGHT - MEDIUM - BROWN. The internal and external degree of cooking can also be set by dragging the cursor to the desired temperature.

6 When pressing the “START STOP” button: PREHEATING starts and a screen appears indicating:

- the current oven cavity temperature;
- the set preheating temperature;
- the option to skip preheating (SKIP PREHEATING).

When the set temperature is reached, a beep signals the end of the preheating\* STEP and an icon appears to indicate that the food should be put in the oven.

After this operation, the cooking steps that have been appropriately modified according to the weight, thickness, and internal/external cooking settings of the product will automatically start after the oven door has been closed.

You can also choose to use the UNOX INTELLIGENT PERFORMANCE (UIP) technology by clicking on the relevant symbol.

section “UIP (UNOX INTELLIGENT PERFORMANCE)” on page 12



- GRILL: grilling foods
- PAN.FRY: steaming vegetables, pan-frying meat and fish and breaded products on *Pan Fry* trays
- ROASTING: cooking roasts
- BRAISED: cooking braised meat
- OVERNIGHT: overnight cooking
- STEAM: steam cooking
- BAKE: baking pastry and bread
- SOUS VIDE: vacuum cooking
- REGEN: regenerating frozen foods



Screen for CHEFTOP MIND.Maps™ ovens

Screen for BAKERTOP MIND.Maps™ ovens



6





## “Mise en place” menu

FOR “PLUS” MODELS ONLY The “Mise en place” menu allows you to remove products with different cooking times, placed in the oven at different times, all at the same time.

### EXAMPLE OF OPERATION

In the example shown here, 3 trays containing different foods need to be ready all at the same time, for example, at **12:00**.

For each tray, a timer will be set with a different end time, as each food requires a different amount of cooking time (e.g. 1:30, 50 mins, 60 mins).

**!** We recommend using timer 1 for the tray at the top of the oven, timer 2 for the tray below and so on. This helps the user to know which tray needs to be taken out when the timer expires (for example, when timer 2 expires, take out the second tray down).

Depending on the preparation time and the time I want the food to be ready, the oven will indicate when each tray needs to be placed in the oven via a beep

(**→** at 10:30 put the first tray in, at 11:00 the second, at 11:10 the third) so that they can all be taken out of the oven at the same time, for example, at **12:00**.

A maximum of 10 timers can be set (corresponding to a maximum of 10 different foods being cooked at the same time).

**!** You can also choose to use the UNOX INTELLIGENT PERFORMANCE (UIP) technology by clicking on the relevant symbol.

**!** [section “UIP \(UNOX INTELLIGENT PERFORMANCE\)” on page 12](#)

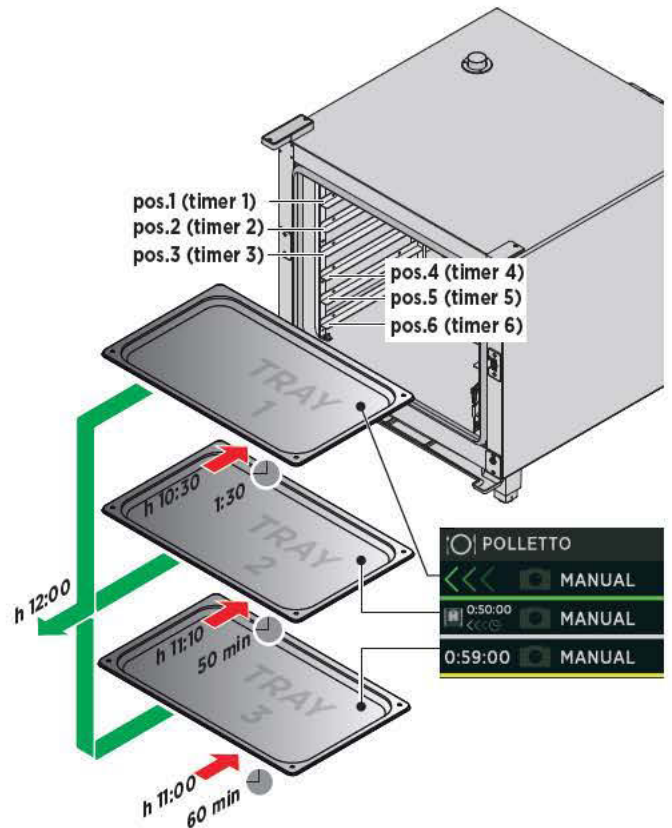

MISE EN PLACE



**3** List of all “Mise en place” menus saved by the user

**2** List of “Mise en place” cooking cycles saved by the user

**1** Setting a “Mise en place” cooking cycle [see section Menu Set on page 16](#)

fig. E1



# 1 NEW "MISE EN PLACE": SET AND SAVE A NEW "MISE EN PLACE" COOKING CYCLE

Here you can create, start and save a new "Mise en place" recipe.

## 1A SETTING THE PARAMETERS

These are set in the same way as explained under "SET MENU".

! The cooking cycle does NOT include:  
- cooking steps;  
- entering a time (cooking is "indefinite").

! Each cooking cycle includes preheating which is set by tapping the arrow < (fig. E3) and accessing page fig. E4.

! For further details see section Preheating settings on page 18 and Menu Set on page 16.

## 1B SAVING THE SET PARAMETERS (OPTIONAL)

If you want to save the cooking cycle, press the "SAVE" button (saving happens in the same way as described under "SET MENU").

! For more information see section Menu Set on page 29 (Saving a cooking cycle).

! You can also choose to use the UNOX INTELLIGENT PERFORMANCE (UIP) technology by clicking on the relevant symbol.

! section "UIP (UNOX INTELLIGENT PERFORMANCE)" on page 12.

## 1C STARTING A COOKING CYCLE

A cooking cycle is launched by tapping the "START/STOP" button from the parameter setting window or, if saved previously, by selecting it from the list, (fig. E5): in this case, the fig. E6 screen will appear, from which you can:

- ① view/modify the saved cooking cycle;
- ② duplicate the cooking cycle (to create one with similar parameters);
- ③ delete a saved cooking cycle: in this case the system requests confirmation before permanently deleting the item;
- ④ create a new menu (for further information, see section "Further information: "NEW MENU" function" on page 47)
- ⑤ create a daily menu (for further information, see section "Further information: "DAILY MENU" function" on page 47);
- ⑥ start the cooking cycle by pressing the "START/STOP" button.

After pressing the "START/STOP" button, preheating starts automatically. This can be skipped by pressing the specific button.

! For further information, see section Preheating settings on page 18.

Once the set temperature has been reached, a beep signals the end of the preheating step and moves on to setting the timers (see fig. E7).



fig. E2



fig. E3



fig. E4



fig. E5



fig. E6



## 1D SETTING THE TIMERS

To set all the timers (cooking duration), tap the symbol “+” on the screen (fig. E7). A screen will open (fig. E8): the timers can be set to time, using the core probe or by selecting a similar recipe.

### Setting a timer

- tap the hours, minutes or seconds field;
- drag the slider or use the buttons **- +** to set the required value;
- confirm by pressing the “START/STOP” BUTTON (fig. E9).

Timer expires based on the time set (in the example: 15 minutes).

### Setting a timer with a core probe

- tap the “core probe” icon, on the right.
- drag the slider or use the buttons **- +** to set the required value;
- confirm by pressing the “START/STOP” button (fig. E9).

Only 1 timer with a core probe can be set.

The timer will expire when the set core probe temperature is reached.

### Setting the timer with a similar recipe

The oven suggests recipes which have been set with the “SET” menu and saved in the “PROGRAMS” menu. These have identical temperature and humidity settings in the oven cavity (in the example: “VEGETABLES”). Tap the desired recipe to select it.

The timer expires based on the time set for the selected recipe (in the example: 20 minutes).

Proceed in the same way for all the timers you need (up to a maximum of 10 simultaneous timers).

The screen at the side (fig. E10) shows a possible cooking cycle scenario (see the example in blue).

The first tray to be placed in the oven (green timer) will always be the one which requires the longest cooking time (in the example: 1:29 mins) or the one which requires the core probe (the time required for it to reach the set temperature cannot be predicted); after this, put the trays in the oven based on the cooking time required for each tray.

! The colour indicates:

- **GREEN:** put the tray in the oven >>>. When the door is closed, the timer turns red indicating that food is being cooked on the tray.

! A beep indicates when a new tray needs to be put in the oven. If you put the tray in the oven within **45 seconds** of the beep, it can be taken out of the oven at the set time (e.g. at 12:00), otherwise, it will need to be taken out of the oven later (for example, it should have gone into the oven at 11:00, I put it in the oven at 11:02 -> the tray will be ready at 12:02 rather than at 12:00).

- **YELLOW:** Next tray to go in the oven.
- **RED:** tray currently in the oven
- **WHITE:** tray waiting to go in the oven



fig. E7

fig. E8

fig. E9

Multi-time recipe “BROCCOLI” set at point A  
Temp.: 120°C  
Humidity: 40%

“VEGETABLES” recipe previously set with the SET menu:  
Duration: 20 minutes  
Temp.: 120°C  
Humidity: 40%

### EXAMPLE:

- TRAY 1 -----> 1st tray to go in the oven  
Duration: 1:29 mins
- TRAY 2 -----> 2nd tray to go in the oven  
Duration: 59 mins
- TRAY 3 -----> 3rd tray to go in the oven  
Duration: 50 mins
- TRAY 4 -----> 4th tray to go in the oven  
Duration: 2 mins



fig. E10







2

## MY "MISE EN PLACE"

In this section the user can recall a previously saved cooking cycle using the "MISE EN PLACE" function.

To access the list of saved cooking cycles, tap the icon "MISE EN PLACE" (fig. E1): this opens a list of all previously saved cooking cycles (fig. E12).

At the bottom of the screen, the arrows  and  are used to scroll through the various cooking cycles saved in the group, while the arrows  and  are used for scrolling through the 16 groups available.

Tap one of the cooking cycles listed (fig. E12) to open the fig. E13 screen that enables you to:

- ① view/modify the saved cooking cycle;
- ② duplicate the cooking cycle (to create one with similar parameters);
- ③ delete a saved cooking cycle: in this case the system requests confirmation before permanently deleting the item.
- ④ create a new menu;
- ⑤ create a daily menu;
- ⑥ start the cooking cycle by pressing the "START/STOP" button.

 For further information, see section Further information: "NEW MENU" function on page 47

 For further information, see section Further information: "DAILY MENU" function on page 47





3

## MY MENU

In this section you can recall a previously saved cooking cycle using the "NEW MENU" function.

 For further information, see section Further information: "NEW MENU" function on page 47

To access the list of saved cooking cycles, tap the "MY MENU" icon (fig. E1). This opens a list of all previously saved cooking cycles (fig. E14).

At the bottom of the screen, the arrows  and  are used to scroll through the various cooking cycles saved in the group, while the arrows  and  are used for scrolling through the 16 groups available.

Tap one of the cooking cycles listed (fig. E14) to open the fig. E15 screen that enables you to:

- ① view/modify the saved cooking cycle;
- ② duplicate the cooking cycle (to create one with similar parameters);
- ③ delete a saved cooking cycle: in this case the system requests confirmation before permanently deleting the item.
- ④ start the cooking cycle by pressing the "START/STOP" button.



fig. E12



fig. E13



6



fig. E14



fig. E15



4

## FURTHER INFORMATION: "NEW MENU" function

The "NEW MENU" function enables you to set up to 10 timers without needing to place trays in the oven or start a cooking cycle.

To set the function:

- ① recall a recipe saved in the "MY MISE EN PLACE" menu (for example, "SMALL CHICKEN");
- ② tap the "NEW MENU" icon;
- ③ set the timers as explained in point ④ on page 45 based on the number of trays which are to be used. The timers are all white showing they are waiting.
- ④ When all the required timers have been set, press the "START/STOP" button on the page that shows all of the timers.
- ⑤ Press "SAVE";
- ⑥ Select where you want to save the menu.

Then, to recall and start the cooking cycle, click on the "MY MENU" menu, tap the recipe to select it and start the cooking cycle using the "START/STOP" BUTTON.

 For further information, see section MY MENU on page 46

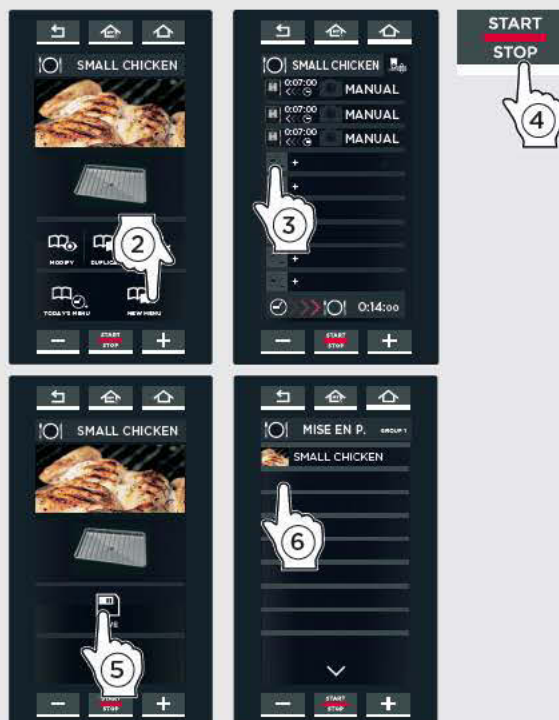

## FURTHER INFORMATION: "DAILY MENU" function

The DAILY MENU function allows you to set up to 10 timers without needing to preheat the oven cavity (if the oven is already warm, for example).

To set the function:

- ① recall a recipe saved in the "MY MISE EN PLACE" menu (in the example: "SMALL CHICKEN");
- ② tap the "DAILY MENU" icon;
- ③ set the timers as explained in point ④ on page 45 based on the number of trays which are to be used. The timers are all white showing they are waiting.
- ④ When all the required timers have been set, press the "START/STOP" button on the page that shows all of the timers.

 For further details, see point ⑤ on page 45

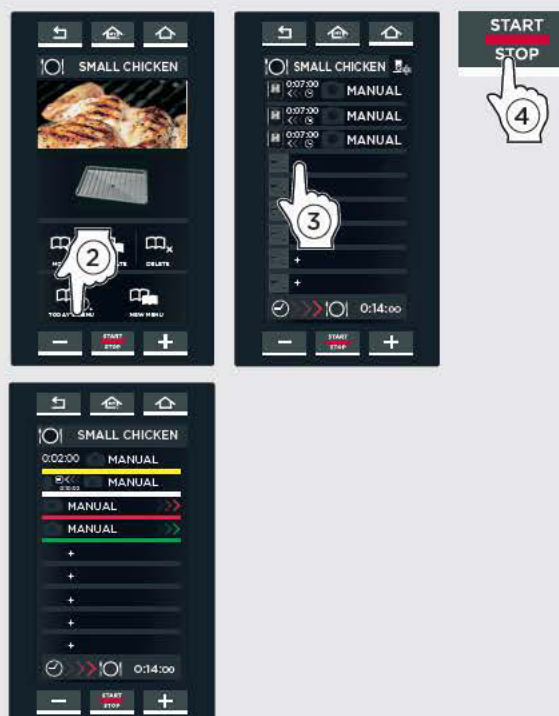





## Rotor.Klean menu

This menu is used to access to the washing list, manage the Unox.Pure filter, and for oven maintenance.

### ROTOR.KLEAN

In this section, start one of the following washing or rinse programs:

WASHING CYCLE	RUN TIME	USE
RINSE	00:06	cold rinse
QUICK	00:30	oven cavity only slightly dirty
SHORT	00:41	cooking cavity slightly dirty
MEDIUM	01:02	cooking cavity averagely dirty
LONG	01:43	oven cavity very dirty

The automatic SENSE.Klean™ technology checks the level of dirt in the oven and displays the result on a coloured bar:

**blue:** oven only slightly dirty (0-60%)

**yellow:** oven averagely dirty (60-90%)

**red:** oven very dirty (over 90%)

using this value, it suggests the most suitable wash, highlighting it with a symbol  (in the example: SHORT - a quick wash).

- 1 Tap the Rotor.Klean icon
- 2 Tap the name of the program you want to start.
- 3 Tap the "START/STOP" button to start the washing cycle. The display shows the time remaining until the end of the washing cycle (in the example, fig. L2 1 minute and 25 seconds remaining).

 The colour of the clock indicates:

- **RED:** washing program in progress.
- **YELLOW:** less than 1 minute until the selected washing program finishes
- **GREEN:** the wash has finished, it automatically returns to the "HOME" page.

 To **stop** a wash cycle in progress in advance, press the "START/STOP" button: a quick rinse cycle will automatically start and run for approximately 6 minutes to remove any trace of residual detergent from the oven cavity.

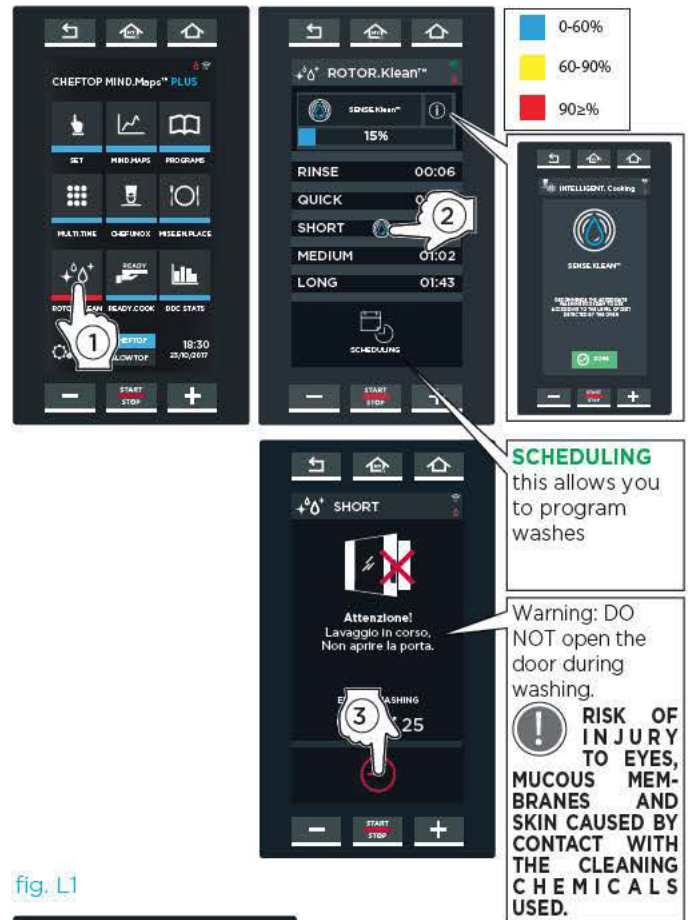

fig. L1

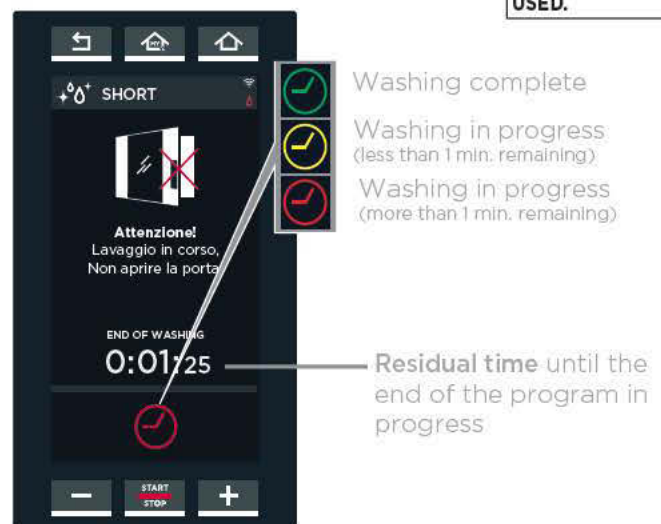

fig. L2



## SCHEDULING WASHES

This menu is used to automate washes, meaning you can be sure to find your oven perfectly clean every day, without worrying about manually launching wash cycles.

The following can be set from this screen using the **-** **+** buttons:

- (A) the washing cycle start time (START WASHING AT);
- (B) the time you want the oven to be ready at (OVEN READY AT) after being washed, rinsed and dried, depending on the chosen program;
- (C) whether the washing cycle only needs to be run once, on the day the programming is set (ONLY ONCE) or every day (EVERY DAY).

**?** **What happens if I set both the start wash time (e.g. 6:00) and the oven ready time (11:00) and I choose a SHORT wash (lasting 41 mins)?**

Once the wash has finished at 6:41, the oven maintains a temperature of approximately 200°C until 11:00.

**?** **What happens if I set the start wash time to 7:00 and the oven ready time to 6:00?**

The oven maintains a temperature of 200°C from 7:41 (the time the wash cycle finishes) until 6:00 the next day.

**?** **What happens if I only set the oven ready time and not the wash start time?**

The oven automatically calculates the start time according to the duration of the wash cycle you have chosen. For example, with a SHORT wash cycle (duration: 41 mins) and the oven ready time set to 11:00, the wash cycle will start at 10:19.

**ONLY ONCE:** the programming runs today only  
**EVERY DAY:** the programming runs every day

**VIEW ACTIVE SCHEDULING:** this is used to view the current program schedule  
**CLEAR SCHEDULING:** cancel all current scheduling

## WARNINGS REGARDING WASHING CYCLES

The ovens come equipped with one/two rotor(s) for cleaning the oven cavity.

- ⚠ Before starting a cleaning cycle, make sure that there are NO trays in the oven chamber, otherwise the washing is ineffective.
- ⚠ **CAREFULLY READ THE PRODUCT SAFETY DATA SHEET BEFORE HANDLING AND USING THE DETERGENT.**
- ⚠ **DO NOT OPEN THE OVEN DOOR DURING WASHING AS THIS COULD CAUSE INJURY TO EYES, MUCOUS MEMBRANES AND SKIN CAUSED BY CONTACT WITH THE CLEANING CHEMICALS USED. THESE CHEMICALS ARE SPRAYED BY THE ROTOR WITHIN THE COOKING CHAMBER AND MOVED BY STRONG AIR CURRENTS.**
- ⚠ For ovens with a trolley, run the washing cycle with the trolley inside the oven cavity, without any trays, and lock the trolley using the front wheel brakes.



When the end is closed with the plug DO NOT use the wash cycle or wash the chamber with large amounts of water as this could cause flooding.

## REFILLING DETERGENT TANK

- ⚠ Only fill with the 1-litre bottles of the **UNOX.Det&Rinse Plus** detergent. To refill the detergent:

1. Wear gloves to prevent your hands from coming into direct contact with the detergent.
2. Pull out the tank from under the oven until you hear a "click".
3. Open the lid of the tank.
4. Open the cap of the UNOX 1-litre detergent bottle **without removing/piercing the protective film**.
5. Turn the bottle upside down and screw it on the tank (by screwing the bottle, a pin in the tank breaks the protective film, which allows the detergent to come out).
6. Once the bottle is empty, unscrew it to remove it. Avoid dripping.

- ⚠ **The detergent must not come into contact with the skin, eyes or mucous membranes.** In case of contact with the detergent, follow the instructions on the safety data sheet.

7. Repeat the process up to the maximum level allowed, indicated on the front of the tank. (Maximum capacity of the 4 litre tank = 4 bottles).
8. Remove the bottle.
9. Reposition the tank under the oven until it stops.
10. Dispose of the gloves, taking care not to touch the areas covered with the detergent.

- ⚠ Never touch the detergent with bare hands.

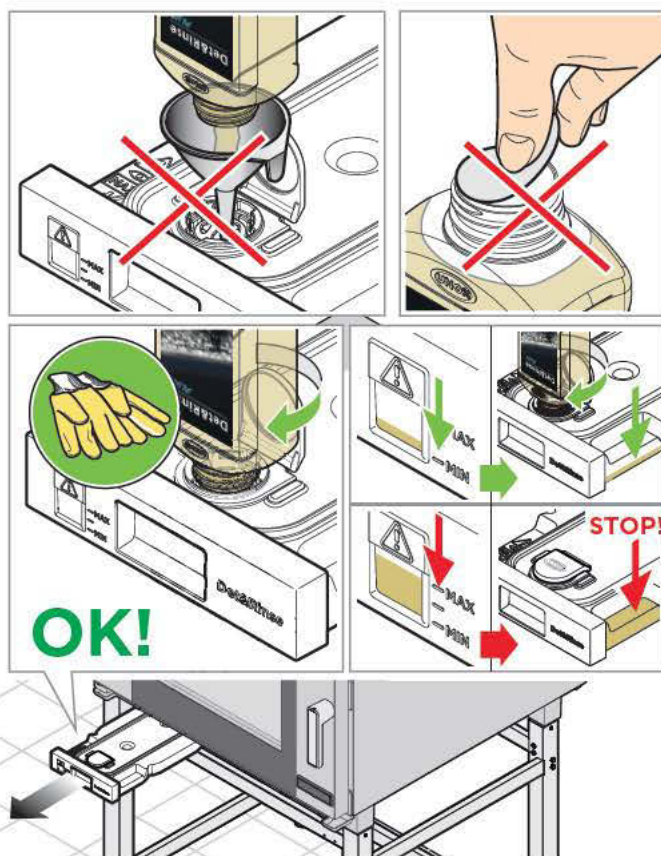

**DO NOT TAMPER WITH THE TANK AND ITS CONNECTIONS TO THE OVEN FOR ANY REASON AS THIS COULD CAUSE A RISK OF INJURY OR DEATH**

- ⚠ Periodically check the presence of rust stains inside the oven chamber: if they are found, contact a Service Centre urgently because the water is probably damaging the oven; prompt action will extend the lifespan of the equipment.





## READY.COOK menu

This is used to access some preset programs, to start certain cooking methods quickly.

- 1 To access the preset programs:
  - 1 tap the “READY.COOK/BAKE icon (for BAKERTOP Mind.Maps™ ovens);
  - 2 select the desired program and the parameters (temperature and steam extraction/ input cannot be changed by the user);
  - 3 tap the “START/STOP” button: a preheating phase will start;
  - 4 after pre-heating, to determine the end of the cooking set up to 4 timers (cooking duration) or use the core probe method (core temperature);
  - 5 start the cooking cycle as normal using the “START/STOP” button.

 The “SAVE FAVOURITE” button is not currently operational.

 You can also choose to use the UNOX INTELLIGENT PERFORMANCE (UIP) technology by clicking on the relevant symbol.

 [section “UIP \(UNOX INTELLIGENT PERFORMANCE\)” on page 12.](#)



The screen side shows a possible cooking cycle in progress.

There are four set timers: three are set by entering a **TIME** (for example, the first, second and fourth), and one is set by inserting the **CORE PROBE TEMPERATURE** (e.g. the third, 70°C).

The colours indicate:

- **GREEN:** timer expired (the food is ready). A beep notifies the user that it is time to take the tray out of the oven. When the door is closed, the timer will disappear from the list.
- **YELLOW:** timer about to expire (the food is almost ready). Prepare to take the tray out of the oven.
- **RED:** timer in operation (dishes still cooking).

READY.COOK



## Stats DDC menu

This menu allows you to control consumption and HACCP data.

The screen provides access to 3 areas:

**A) GOAL:** you must set the daily number of oven operating hours, which is required to optimise costs. A histogram is then shown to indicate whether you achieved the goal. This helps you to understand whether you are using the oven in the best way possible.

**B) HACCP:** HACCP data can be used to monitor the processing of foods for which there a risk of biological, chemical or physical contamination.

More specifically, every 30 seconds the following readings are taken:

- oven cavity temperature;
- temperature measured by the core probe;
- vacuum-seal (sous vide) probe temperature.

**C) CONSUMPTION:** tap the "CONSUMPTION" icon to call up a screen showing the dates the oven was used.



### A SETTING GOALS

- 1 Select the option shown.
- 2 Move the blue bar or use the buttons **-** **+** to set the number of hours the oven should be used for per day, in order to optimise costs (e.g. 14:00 hours).
- 3 Save by pressing the "SAVE" button.
- 4 Choose whether you want to view the goals per day, per week or per month. A grey line (representing the time set, e.g. 14 hours) and a histogram will appear.

In the histogram:

- the blue bars indicate when the goal has been achieved (i.e. that the 14 hours of daily oven operation have not been exceeded)
- the red bars indicate when the goal has NOT been achieved.

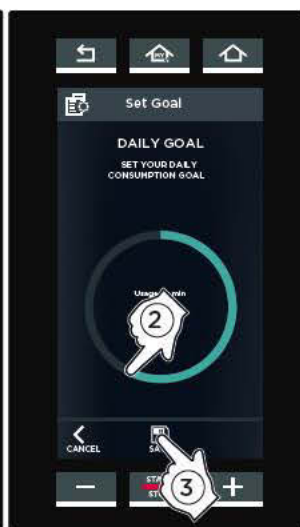

Display goals per week:  
e.g. from the 18th to the 24th of December

22 hours: goal achieved

14 hours: goal set

12 hours: goal NOT achieved



## B HACCP DATA

- ① Select the oven operating date for which you want to see the HACCP data.
- ② The relative data are displayed during operation.



## C CONSUMPTION

When touching the “CONSUMPTION” icon, a screen appears that shows the dates on which the oven was used.

- ① select the date for which you want to view the consumption data:
- ② select the oven operational period: the following consumption is shown:
  - electricity/gas consumed;
  - litres of water consumed to make the steam in the oven cavity;
  - litres of water and detergent consumed for the washing cycles.



DATE



## Settings

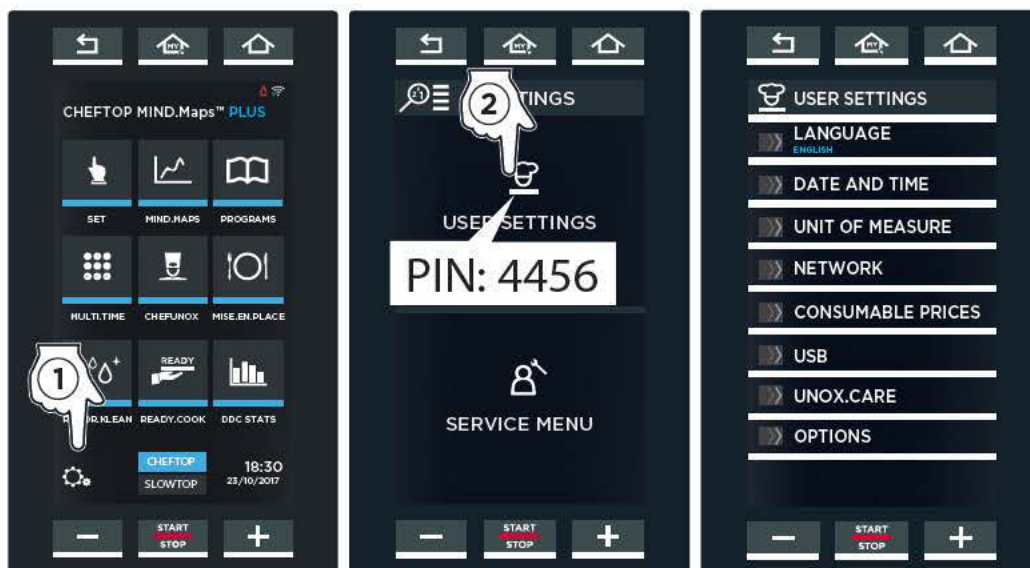

This menu enables the user to set the oven parameters.

The SERVICE MENU is for specialist operators only, whereas the "USER SETTINGS" can be accessed by any operator by entering the password "4456" and confirming with "OK".



1

### LANGUAGE

Here you can select your preferred language, which will be used for all menu entries. You can scroll through the list of languages using the arrows  and .

ENGLISH, ITALIANO, FRANÇAIS, ESPAÑOL, DEUTSCH, CESKY, РУССКИЙ, KOREAN, SRPSKI, CHINESE, SLOVENSKY, PORTUGUÊS, JAPANESE, ROMANA, DANSK, SVENSKA, POLSKI, SLOVENŠČINA, NEDERLANDS, БЪЛГАРСКИ, ภาษาไทย, ΕΛΛΗΝΙΚΑ, MAGYAR, TÜRK, HRVATSKI and EESTI





2

### DATE AND TIME

The user can modify the oven "date and time" settings.

The following values must be set:

- the time zone, by clicking on the relevant geographic area and selecting the country, scrolling through the list using the arrows  and .
- daylight saving time, i.e. whether daylight time saving or standard time is in effect at this time; alternatively, "AUTOMATIC" enables automatic updating;
- if you want the time and date to be updated automatically.



3

### UNIT OF MEASURE

The user can select the unit of measurement:

- temperature (°C/°F);
- volume (litres or gallons);
- thickness (mm or inches);
- weight (kg or pounds);
- energy (kWh or BTU);

It also allows you to set the current currency (€, \$, etc.) and, by entering this menu, you can also set:

- whether the currency symbol should come before or after the value;
- whether to use "." or "," for decimal numbers.



4

### NETWORK

This menu enables or disables oven control via remote network access and allows you to configure the relevant parameters.

#### Connection test

Connection test for all three types of connection

#### Cloud PIN

The PIN code needed to add the oven both on DDC.unox.com and on the app. Each oven has its own PIN code. The first time the oven is turned on, it is already set. Where necessary, it can be personalised.

#### DHCP

This allows you to obtain the network settings from the DHCP server (for Wi-Fi connections, always leave the DHCP set to "ON").

For cable connections, the network settings can be inserted manually.

Where there is a SIM card, the following appears:

#### Signal level

**PIN** for the SIM card (only where the card has a PIN)

**APN** (depending on the operator; search online) if it is not entered, you cannot connect to the oven.

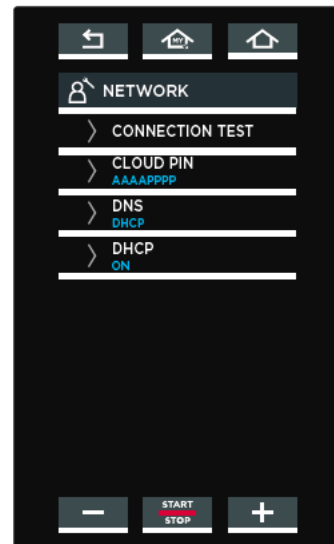

5

### CONSUMABLE PRICES

It allows you to enter the cost of electricity, water and detergent (the currency is set in the "Unit of measurement" section on this screen)

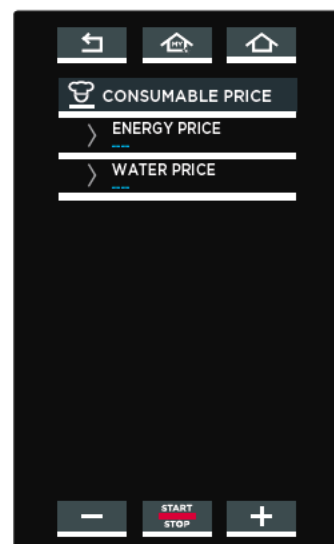

## 6 USB

This section allows you to import or export material from your own USB stick (FT32 formatted and with capacity between 4 GB and 16 GB).

- EXPORT PROGRAMS: exports recipes from the oven to a USB stick;
- IMPORT PROGRAMS: exports recipes from a USB stick to the oven;
- IMPORT PICTURE: imports images from the USB stick to the oven, for example a photo of one of your successful dishes. The images must be converted before they can be used. Follow the procedure shown in the drawing, point ① to ⑦.
- EXPORT HACCP TO USB: export the HACCP data detected by the oven to a USB stick.

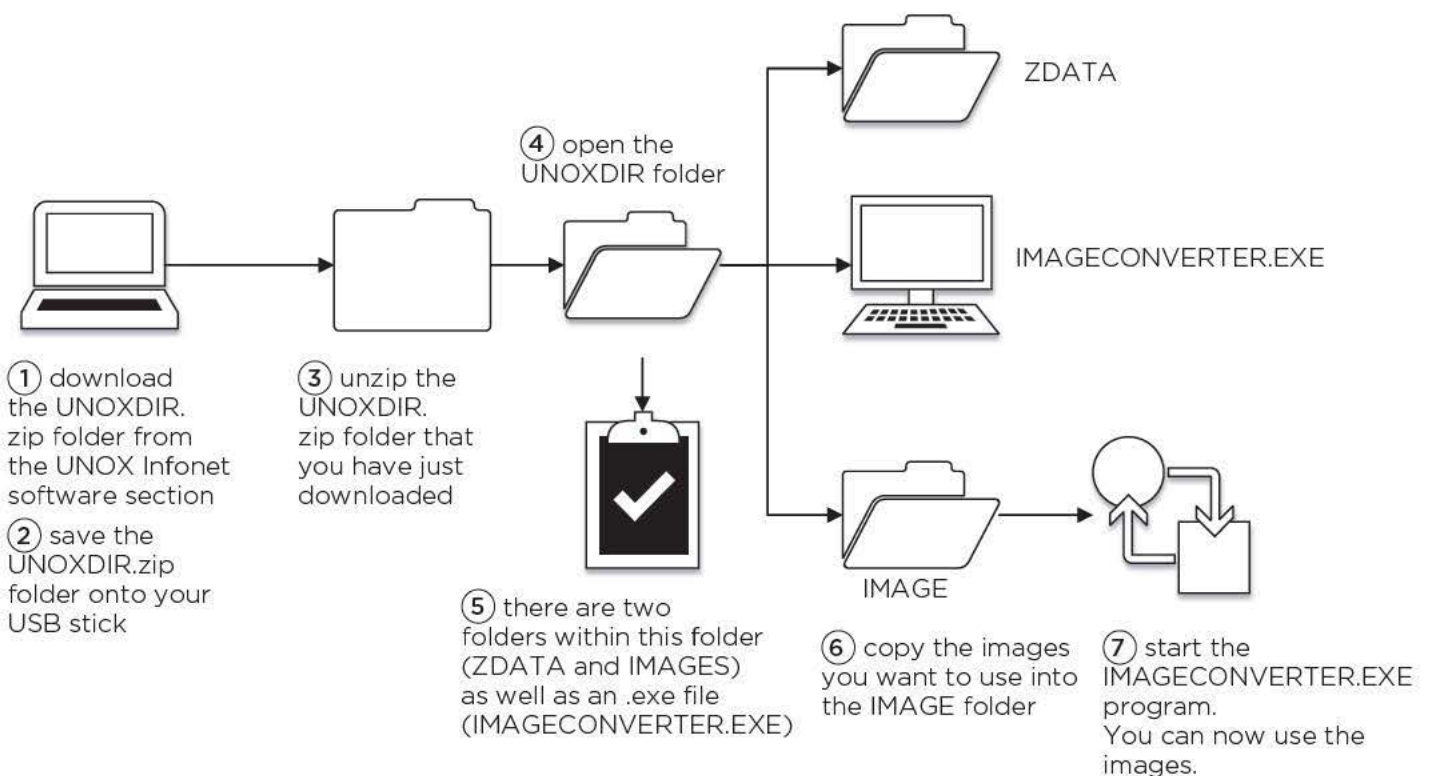
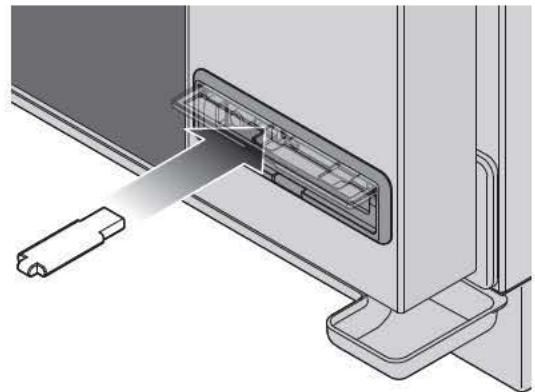
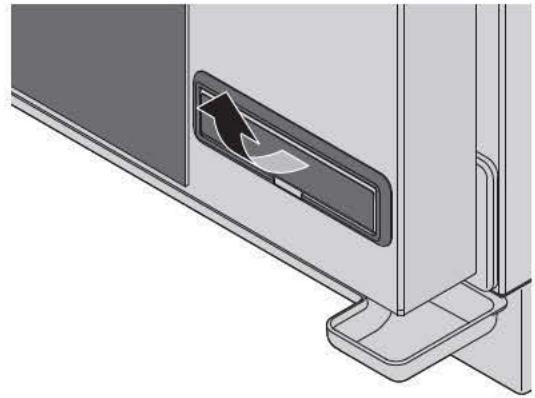



## 7 UNOX.CARE

### UNOX.PURE

#### ① Filterable volume

Thanks to an internal litre counter (which has to be reset each time the filter is changed), the user can find out at any given moment how many litres of incoming water remain until the filter will next need changing.

#### ② Water hardness

The hardness of the water can be set on this screen within a range of 3 °dH to 10 °dH (German degrees).

#### ③ Activate the counter

After having replaced the filter, the litre counter must be reset so that it starts counting from zero again. To carry out this operation, enter the PIN code identified on the kit box.

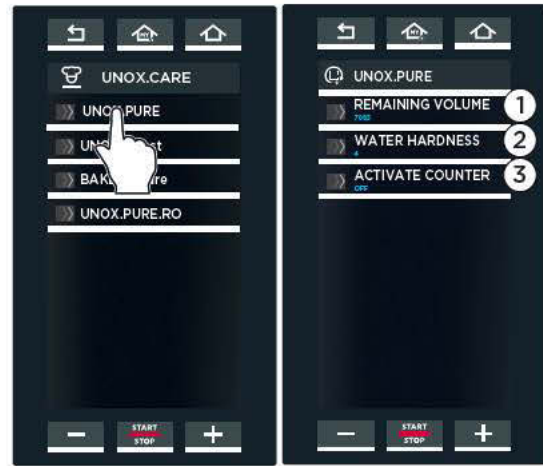

### UNOX.PURE-RO

#### ① Filterable volume

Thanks to an internal litre counter (which has to be reset each time the filter is changed), you can view how many litres of incoming water are left at any given moment until the filter will next need changing (in the example: 7,083 litres remaining before the filter needs replacing).

#### ② Water hardness

In order for the OSMOSI system to work properly, this parameter must be set to "ON" (default is "OFF"). If, for any reason, the reverse osmosis system is removed from the oven, or while waiting for a repair, set it back to "OFF".

#### ③ Activate the counter

After having replaced the filter, the litre counter must be reset so that it starts counting from zero again. To do this, you need to access the screen and confirm (DELETE).

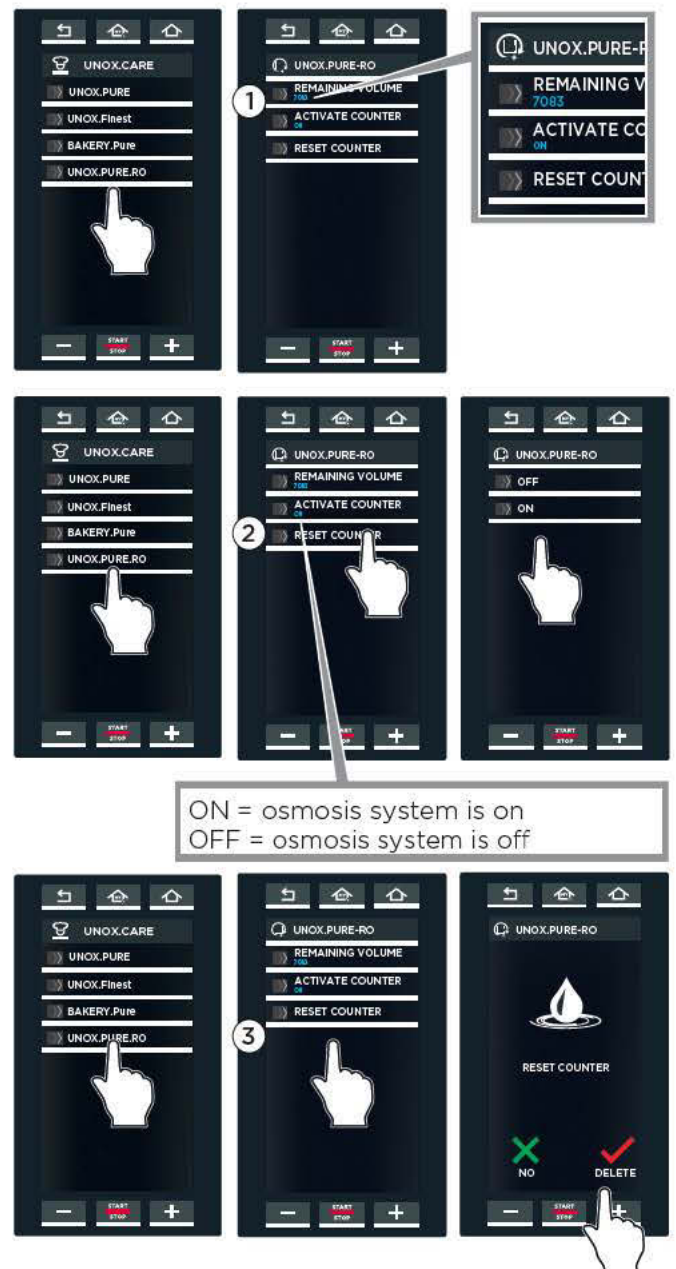

## 8 OPTIONS

### 1 CONSUMPTION DATA IN CURRENCY

When active ("ON"), it converts consumption data (e.g. litres used for steam) into costs, based on the currency set.



### 2 LOCKS

From this entry, you can access three submenus:

#### Lock program view

##### LOCK PROGRAM VIEW

This allows you to start cooking programs stored by users but prevents them from being viewed, edited or deleted.

#### Lock user program

##### (LOCK USER PROGRAM)

This allows you to start and view the cooking programs saved by users but prevents them from being edited and deleted.

#### Lock manual cooking

##### LOCK MANUAL COOKING)

Blocks manual cooking (SET menu).



### 3 SMOOTH PREHEATING

If the AF02 alarm (the safety thermostat alarm) reappears frequently, you can activate the SMOOTH function, for a more delicate preheat.

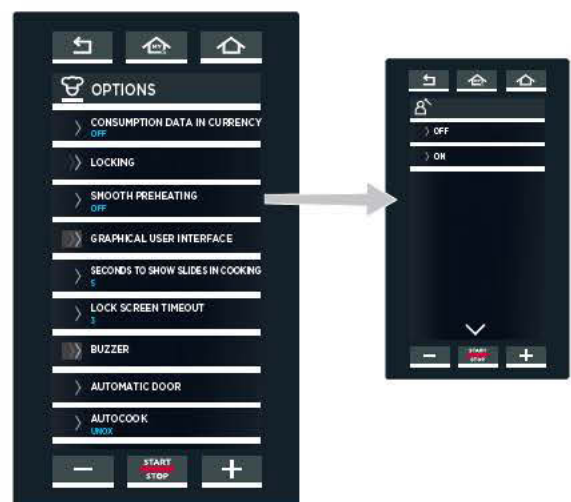

#### 4 USER INTERFACE

From this entry, you can access two submenus:

##### Home page icons

(HOME PAGE ICONS):

some of the main menu icons can be set from this submenu (SET, PROGRAMS, MULTITIME, etc.):

Settings:

SHOW: normal display of the selected icon

HIDE: hide the selected icon

SKIP: if some icons are skipped, the remaining icons rearrange themselves to fill the empty spaces

LOCK: lock the menu but leave it visible

DEACTIVATE: lock the menu and make it barely visible.

##### Show full menu

(SHOW FULL MENU):

if this is set to "ON", the parameters for all accessories are shown (even if not installed).

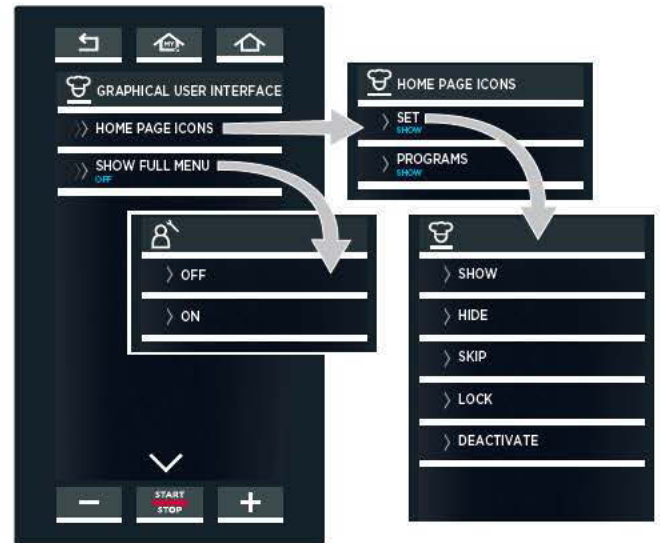

#### 5 SECONDS TO SHOW SLIDES IN COOKING

Set how long to display the cooking process screens for before going to the next screen.

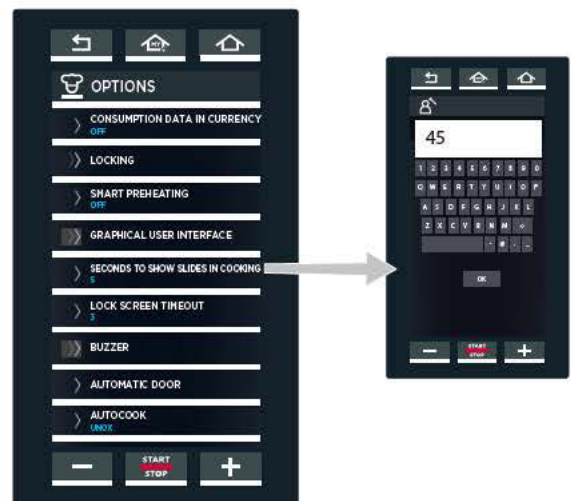

#### 6 LOCK SCREEN TIMEOUT

If the oven door is opened, the screen on the side warns that it is not possible to use the display for safety reasons.

When the door is closed, the screen is operational again.

If the door remains open for a long time, the display unlocks automatically after a specific time set by the operator using this menu (time in seconds; in the example: 3 seconds).





## 7 BUZZER

The following can be set:

the **duration** of the beep at the end of the cooking/leavening cycle, in seconds. Set the value using the keypad and confirm with "OK";

the **volume** of the beep at the end of the cooking/leavening cycle, choosing from: high, medium or low;

**ON** or **OFF** for the optional external beep, where installed.

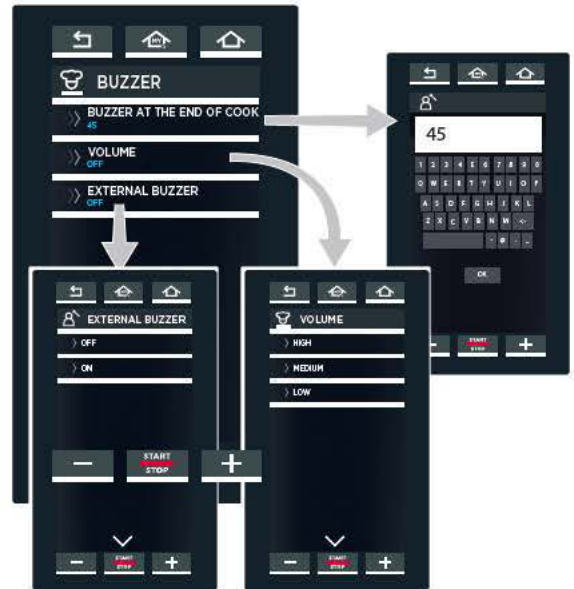

## 8 AUTOMATIC DOOR

The following can be set:

- if you have an oven with an automatic door **(YES)**;
- if you **DO NOT** have an oven with an automatic door **(NO)**.

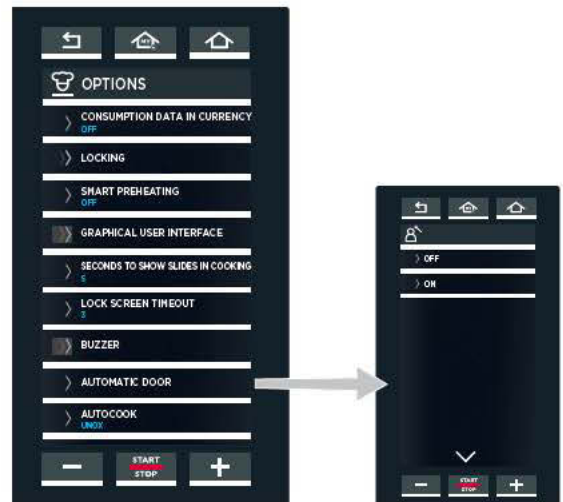

## 9 AUTOCOOK

Add the list of programs for a specific country to the list of saved UNOX chef programs.



# Oven-user interface

The ovens show any alarm/warning messages relating to the oven or installed accessories on the screen. The warning messages (WARNING) signal malfunctions that allow the appliance/accessories to continue operating, but with a restricted set of functions.

The alarm messages (ALARM) identify issues that prevent any operation whatsoever of the appliances/accessories, which therefore must be put into STOP mode.

If the alarm messages refer to the connected accessories, the oven can still be used.

AF - OVEN ALARMS			
Display	Description	Effect	Solution
AF01	Motor thermal alarm	The oven stops any operating cycle and blocks any screen display configuration	Contact the Customer Assistance Service
AF02	Safety thermostat alarm		
AF03	Oven cavity alarm		
AF04	Communications failure alarm		
AF20	Hood thermostat alarm	The oven program cannot be started until the temperatures return to within regulatory limits and until the user presses the "reset hood" button	Wait for the temperatures to drop and then press the reset button. If the problem persists, contact the customer assistance service
AF23*	No gas supply	The oven stops any operating cycle and blocks any screen display configuration	Contact the Customer Assistance Service
AF25**	Trolley alarm	The oven does not allow the programs to start, with the exception of preheating	Correctly position the trolley inside the oven chamber, if the problem persists, contact the customer assistance service

- \* only for gas ovens
- \*\* only for ovens with trolleys

If the AF23 - GAS REARM shows, this means there is no gas supply. In this case, contact an authorised support service, calling the number on the display (UNOX SERVICE). If you press the "IGNORE" button, a warning screen is shown. If you ignore the alarm, the oven cannot be used. If you press the "OTHER N°" button, a list of additional support service numbers is shown.

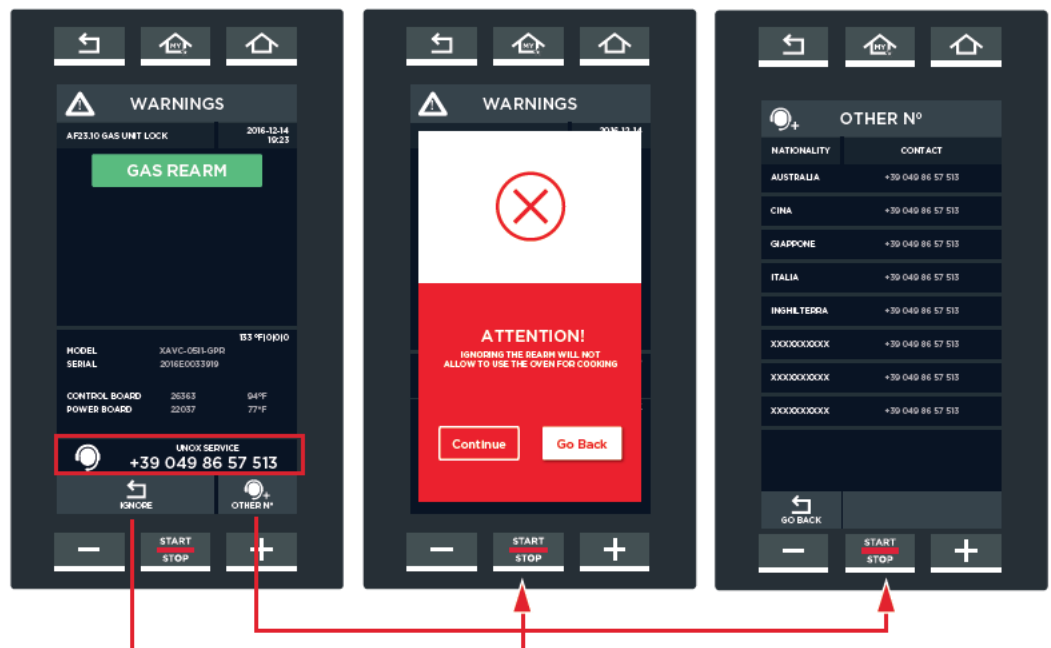

<b>WF - OVEN WARNING</b>			
<b>Display</b>	<b>Description</b>	<b>Effect</b>	<b>Solution</b>
WF01	Warning: cavity 1 probe (rear)	The oven continues to run using the cavity 2 probe, therefore temperature adjustments may be less accurate	Contact the Customer Assistance Service
WF02	Warning: cavity 2 probe (front)	The oven continues to run	
WF03	Warning: core probe	The oven continues to run but the core probe cannot be used for cooking cycles	
WF04	Warning: motor tachometer	The oven will continue to operate, but humidity detection is disabled	
WF06	Warning: power board temperature		
WF12	Warning: vacuum-cooking (sous vide) board temperature	The oven continues to run but the external sous vide (vacuum cooking) probe cannot be used	
WF13	Warning: vacuum-seal (sous vide) probe		
WF15	Warning: communication failure with the vacuum-cooking (sous vide) board		
WF16	Warning: lack of water or EL 1 water valve	The oven will continue to operate but washing may not be effective	Check the reason for the lack of water. If the problem persists, contact the customer assistance service
WF17	Warning: multipoint probe on 1 or more measuring points (up to 3)	The oven continues to run but the core temperature reading may be inaccurate	
WF18	Warning: "Pollo" valve rotating	It is not possible to switch from cooking chicken to a washing cycle and/or vice versa	
WF19	Lack of detergent in the tank below the oven	The washing cycle stops and the system starts forced rinsing	Load the detergent; if the problem persists, contact the customer assistance service
WF20	Lack of water to the EG 1 impeller valve	The washing programs start as normal but, due to the impeller malfunctioning, cleaning is not performed correctly	Contact the Customer Assistance Service
WF25	Lack of water to the EI 2 valve	The washing programs start as normal but, due to the problem, the back side of the sheet metal fan cover is not washed	Contact the Customer Assistance Service
WF26	Lack of water to the EG 2 impeller valve	The washing programs start as normal but, due to the impeller malfunctioning, cleaning is not performed correctly	
WF27	Lack of water to the EL 1 valve	No washing possible	Check the reason for the lack of water. If the problem persists, contact the customer assistance service
WF28	Warning: control board temperature	The oven continues to run	Contact the Customer Assistance Service
WF29	Warning: gas smoke temperature	The oven continues to operate but performance may be low	
WF30	Communication error with the smoke board	The oven continues to operate but performance may be low	Contact the Customer Assistance Service
WF31	High smoke board temperature	The oven continues to run	



**WC - COOKER HOOD WARNING**

Display	Description	Effect	Solution
WC01	Smoke detector 1 broken	Smoke hood solenoid valve does not open when a smoke temperature probe is missing	Contact the Customer Assistance Service
WC02	Board temperature error	The hood continues to operate	
WC05	Inlet fumes too hot	The hood continues to operate	
WC06	No power supply	Motor and smoke hood disengaged	
WC07	Communication lost	Motor and smoke hood disengaged	Check the hood power cable; if the problem persists, contact the Customer Assistance Service

**AL - PROVER ALARM**

Display	Description	Effect	Solution
AL01	Cavity probe alarm	The prover stops any operating cycle and blocks any screen display configuration	Contact the Customer Assistance Service
AL02	Communications failure alarm		Check the power cord on the prover. If the problem persists, contact the customer assistance service
AL03	No 230 V power supply to the prover board		

**WL - PROVER WARNING**

Display	Description	Effect	Solution
WL01	Humidity probe error	The prover continues to run but the automatic humidity adjustment feature cannot be used	Contact the Customer Assistance Service
WL02	Board temperature error		
WL03	Component compartment probe error	The prover continues to run	

**AM - MAINTAINER ALARMS (SlowTop)**

Display	Description	Effect	Solution
AM01	Cavity probe alarm	The maintainer stops all operating cycles and blocks any further display screen configuration	Contact the Customer Assistance Service
AM02	Communications failure alarm		
AM03	Safety thermostat alarm		
AM04	Motor thermal alarm		
AM05	Motor tachometer alarm		

**WM - MAINTAINER WARNING (SlowTop)**

Display	Description	Effect	Solution
WM02	Board temperature error	The maintainer continues to run	Contact the Customer Assistance Service
WM03	Core probe error	The maintainer continues to run but core probe processes cannot be activated	

### Cleaning

- !** Any routine maintenance procedure must be performed:
- after having disconnected the power, water and gas supplies to the appliance (GAS ONLY FOR GAS OVENS)
  - after having put on the proper personal protective equipment (gloves, etc.).

Clean the oven cavity daily to maintain proper levels of hygiene and to prevent the stainless steel inside the oven cavity from becoming damaged or corroding. Clean the oven daily even if the appliance is used exclusively with steam.

When cleaning any component or accessory NEVER use:

- abrasive or powder detergents;
- aggressive or corrosive detergents (e.g. hydrochloric/muriatic or sulphuric acid). Caution! Never use these substances when cleaning the appliance substructure or the floor under the appliance;
- abrasive or sharp tools (abrasive sponges, scrapers, steel bristled brushes, etc.);
- water jets.

#### EXTERNAL STEEL STRUCTURES, OVEN CAVITY SEAL, CORE PROBE

**Wait for the surfaces to cool off.**

Use only a soft cleaning cloth dampened with a little soap and water. Rinse and dry completely.

Alternatively, only use detergents recommended by UNOX; other products may cause damage, thereby invalidating the warranty\*. Read the usage instructions provided by the detergent manufacturer.

#### INSIDE THE OVEN CAVITY

- !** Failure to clean the oven cavity daily can cause the accumulated grease and food residues inside to catch fire - this is a fire hazard.

Use the washing cycle programs to clean the oven cavity.

- !** For further information, see section **ROTOR.KLEAN** on page 48



#### PLASTIC SURFACES AND CONTROL PANEL

Use only a very soft cleaning cloth and a small amount of detergent for cleaning delicate surfaces.

#### OVEN DOOR INTERNAL AND EXTERNAL GLASS

**Wait for the windows to cool off.**

Use only a soft cleaning cloth dampened with a little soapy water or detergent specifically designed for glass.

Rinse and dry completely.



When the end is closed with the plug DO NOT use the wash cycle or wash the chamber with large amounts of water as this could cause flooding.

\* For further details go to the "Warranty" section of the website [www.unox.com](http://www.unox.com)





## Inactivity

During periods of inactivity, take the following precautions:

- disconnect the power, water and gas supplies to the appliance (ONLY FOR GAS OVENS);
- preferably rub a soft cloth lightly doused with mineral oil on all stainless steel surfaces;
- keep the appliance door slightly ajar.

- Before reusing the appliance:

clean the appliance and its accessories thoroughly (see section **Cleaning** on page **64**);

- reconnect the appliance to the power, water and gas supplies (GAS ONLY FOR GAS OVENS);
- inspect the appliance before using it again;
- switch on the appliance at minimum temperature for 50 minutes without any food inside it.

 **To ensure that the appliance is in perfect condition in terms of use and safety, maintenance and inspections should be performed at least yearly by an authorised support service centre.**

## Disposal

Pursuant to Article 13 of Italian Legislative Decree no. 49 (2014) "Implementation of the WEEE Directive 2012/19/EU on electrical and electronic equipment waste":



The crossed-out wheeled bins symbol indicates that the product was placed on the market after 13 August 2005 and that, at the end of its useful life, it should not be disposed of with other waste, but must be collected separately.

All appliances are made with recyclable metal materials (stainless steel, iron, aluminium, galvanized steel, copper, etc.) in percentages above 90% by weight.

Before disposal, make the appliance unusable by removing the power cable and all compartment or cavity closure devices (where present).

At the end of its useful life, the product must be disposed of in such a way as to reduce any negative impact on the environment and make efficient use of available resources. Prefer prevention, preparation for reuse, recycling and reclamation, and remember "the polluter pays". Please remember that illegal or incorrect disposal of the product incurs penalties, as provided for by current legislation.

### Information on disposal in Italy

In Italy, WEEE appliances must be delivered to:

- recycling centres (also known as waste disposal sites/facilities)
- the dealer from whom a new appliance is purchased, who is required to collect them free of charge ("one-for-one" exchange);

### Information on disposal in European Union countries

The EU Directive on WEEE appliances has been implemented differently by each country. Therefore, if you want to dispose of this appliance, we recommend you contact your local authorities or dealer for information on the correct disposal method.

## Certification

### EU declaration of conformity for electrical and gas appliances

Manufacturer: UNOX S.p.A.

Address: Via Majorana, 22 - 35010 Cadoneghe, Padua, Italy  
declares, under its own responsibility, that the product

#### **CHEFTOP-BAKERTOP MIND.Maps™**

For electric and gas ovens:

complies with the Machinery Directive 2006/42/EC through the following standards:

EN 60335-1: 2014 + A1:2014

EN 60335-2-42: 2003 + A1: 2008 + A1:2012

EN62233: 2008

EN 60335-2-102:2006 + A1:2010

complies with the Electromagnetic Compatibility Directive 2014/30/EC through the following standards:

EN 55014-1: 2006 + A1: 2009 + A2: 2011

EN 55014-2: 1997 + A1: 2001 + A2: 2008

EN 61000-3-2: 2006 + A1: 2009 + A2: 2009

EN 61000-3-3: 2008

EN 61000-3-11: 2000

EN 61000-3-12: 2011

EN 61000-6-2: 2005

EN 61000-6-3: 2007

Only for gas ovens:

is compliant to the Gas Appliances Directive 2009/142/EC through the following standards:

EN 203-1: 2014 / EN 203-2-2: 2006



## INTERNATIONAL

### UNOX S.p.A.

Via Majorana 22 / 35010 Cadoneghe (PD) Italy  
Tel +39 049 8657511 / Fax +39 049 8657555  
[info@unox.com](mailto:info@unox.com)



INVENTIVE SIMPLIFICATION

## EUROPE

### ITALIA

**UNOX S.p.A.**  
E-mail: [info@unox.it](mailto:info@unox.it)  
Tel.: +39 049 86 57 511

### ČESKÁ REPUBLIKA

**UNOX DISTRIBUTION s.r.o.**  
E-mail: [info.cz@unox.com](mailto:info.cz@unox.com)  
Tel.: +420 241 940 000

### РОССИЯ, ПРИБАЛТИКА И СТРАНЫ СНГ UNOX РОССИЯ

E-mail: [info.ru@unox.com](mailto:info.ru@unox.com)  
Tel.: +7 (499) 702-00-14

### ESPAÑA

**UNOX PROFESIONAL ESPAÑA S.L.**  
E-mail: [info.es@unox.com](mailto:info.es@unox.com)  
Tel.: +34 900 82 89 43

### SCANDINAVIAN COUNTRIES

**UNOX SCANDINAVIA AB**  
E-mail: [info.se@unox.com](mailto:info.se@unox.com)  
Tel.: +46 (0)768 716 422

### UNITED KINGDOM

**UNOX UK Ltd.**  
E-mail: [info@unoxuk.com](mailto:info@unoxuk.com)  
Tel.: +44 1252 851 522

### PORTUGAL

**UNOX PORTUGAL**  
E-mail: [info.pt@unox.com](mailto:info.pt@unox.com)  
Tel.: +351 918 228 787

### DEUTSCHLAND

**UNOX DEUTSCHLAND GmbH**  
E-mail: [info.de@unox.com](mailto:info.de@unox.com)  
Tel.: +49 2951 98760

### FRANCE, BELGIUM & LUXEMBOURG

**UNOX FRANCE s.a.s.**  
E-mail: [info@unox.fr](mailto:info@unox.fr)  
Tel.: +33 4 78 17 35 39

### ÖSTERREICH

**UNOX ÖSTERREICH GmbH**  
E-mail: [bestellung@unox.com](mailto:bestellung@unox.com)  
Tel.: +43 800 880 963

### HRVATSKA

**UNOX CROATIA**  
E-mail: [narudzbe@unox.com](mailto:narudzbe@unox.com)  
Tel.: +39 049 86 57 538

### TÜRKİYE

**UNOX TURKEY** Profesyonel Mutfak Ekipmanları Endüstri ve Ticaret Limited Şirketi  
E-mail: [info.tr@unox.com](mailto:info.tr@unox.com)  
Tel.: +90 530 176 62 03

### IRELAND

**UNOX IRELAND**  
E-mail: [info.ie@unox.com](mailto:info.ie@unox.com)  
Tel.: +353 (0) 87 32 23 218

### БЪЛГАРИЯ

**UNOX BULGARIA**  
E-mail: [info.bg@unox.com](mailto:info.bg@unox.com)  
Tel.: +359 88 23 13 378

## ASIA & AFRICA

### MALAYSIA & SINGAPORE

**UNOX (ASIA) SDN. BHD**  
E-mail: [info.asia@unox.com](mailto:info.asia@unox.com)  
Tel.: +603-58797700

### OTHER ASIAN COUNTRIES

**UNOX (ASIA) SDN. BHD**  
E-mail: [info.asia@unox.com](mailto:info.asia@unox.com)  
Tel.: +603-58797700

### PHILIPPINES

**UNOX PHILIPPINES**  
E-mail: [info.asia@unox.com](mailto:info.asia@unox.com)  
Tel.: +63 9173108084

### 대한민국

**UNOX KOREA CO. Ltd.**  
이메일: [info.asia@unox.com](mailto:info.asia@unox.com)  
전화: +82 2 69410351

## AMERICA & OCEANIA

### U.S.A. & CANADA

**UNOX Inc.**  
E-mail: [infousa@unox.com](mailto:infousa@unox.com)  
Tel.: +1 800 489 8669

### MEXICO

**UNOX MEXICO, S. DE R.L. DE C.V.**  
E-mail: [info.mx@unox.com](mailto:info.mx@unox.com)  
Tel.: +52 1555 4314 180

### BRAZIL

**UNOX BRAZIL**  
E-mail: [info.br@unox.com](mailto:info.br@unox.com)  
Tel.: +55 11 98717-8201

### U.A.E.

**UNOX MIDDLE EAST DMCC**  
E-mail: [info.uae@unox.com](mailto:info.uae@unox.com)  
Tel.: +971 55 426 3167

### SOUTH AFRICA

**UNOX SOUTH AFRICA**  
E-mail: [info.sa@unox.com](mailto:info.sa@unox.com)  
Tel.: +27 845 05 52 35

### INDONESIA

**UNOX INDONESIA**  
E-mail: [info.asia@unox.com](mailto:info.asia@unox.com)  
Tel.: +62 81908852999

### 中华人民共和国

**UNOX TRADING (SHANGHAI) CO. Ltd.**  
电子邮件: [info.china@unox.com](mailto:info.china@unox.com)  
电话: +86 21 56907696

### COLOMBIA

**UNOX COLOMBIA**  
E-mail: [info.co@unox.com](mailto:info.co@unox.com)  
Tel.: +57 350 65 88 204

### AUSTRALIA

**UNOX AUSTRALIA PTY Ltd.**  
E-mail: [info@unoxaustralia.com.au](mailto:info@unoxaustralia.com.au)  
Tel.: +61 3 9876 0803

### NEW ZEALAND

**UNOX NEW ZEALAND Ltd.**  
E-mail: [info@unox.co.nz](mailto:info@unox.co.nz)  
Tel.: +64 (0) 800 76 0803

L12450A 3.D00-LDI-01 - Printed: 02-2018  
All images used are for illustrative purposes only.  
All features indicated in this catalogue may be subject to change and could be updated without notice.

UNOX.COM | FOLLOW US ON

