



USE AND MAINTENANCE (TRANSLATION OF THE ORIGINAL INSTRUCTIONS)





SAFETY	4
GENERAL INFORMATION	10
USE SET MENU.....	20
USE MIND.MAPS MENU	34
USE PROGRAMS MENU	38
USE MULTI.TIME MENU.....	42
USE CHEFUNOX MENU.....	48
USE MISE EN PLACE MENU	52
USE ROTOR.KLEAN MENU.....	58
USE READY.COOK MENU	62
STATS DDC MENU.....	64
SETTINGS MENU.....	68
ALARMS & WARNINGS.....	76
MAINTENANCE.....	78
SUPPORT	82

CONTACTS

Please see the back cover for contacts in your local area.



Dear Customer,

This manual contains all the information you need to use and maintain this appliance correctly.

If you do not fully understand any of the contents, please contact the manufacturer for further information.

Safety

Pictograms	4
Safety information	5

PICTOGRAMS



Read the instruction manual



Danger! Situation presenting immediate danger, or a hazardous situation which could cause injury or death.



Risk of fire!



Risk of electric shock!



Danger: risk of burns



Danger: harmful substances



Tips and useful information



Consult another section



Earthing symbol



Equipotential symbol

SAFETY INFORMATION



General precautions

- Failure to comply with the safety regulations, and any use or maintenance other than those indicated in this manual voids the warranty* and relieves the manufacturer of all liability.
- Keep this appliance out of the reach of children.
- Cleaning and maintenance must be done by the user and NOT by children, especially where not supervised by an adult.
- This appliance can only be used for cooking food in industrial and professional kitchens by qualified personnel, who have completed regular training courses. Any other use is not compliant with the scope of use and is therefore hazardous.
- If the appliance is not working or if you notice any changes to the structure or operation, disconnect the electricity supply and contact an authorised UNOX customer assistance service. Do not attempt to repair the appliance yourself. For any repairs, please request UNOX original spare parts.
- Failure to observe these regulations may cause damage, injury or death, and also invalidates the warranty.
- To ensure that the appliance is in perfect condition in terms of use and safety, maintenance and inspections should perform at least yearly by authorised service centre.
- The appliance emits a sound level of below 70 dB.
- The humidity sensing system must be calibrated when the oven is first installed (contact the UNOX Service Centre) and as and when the oven requires it.



If the BAKERTOP MIND.Maps™ oven cannot be permanently connected to a drainage system, the end can be shut off using the cone-shaped stopper supplied in the starter kit. When the end is closed with the plug DO NOT use the wash cycle or wash the chamber with large amounts of water as this could cause flooding.



Risk of burns and injury!

- While cooking and until all appliance parts have cooled, make sure to only touch the appliance control components or handle, because the external parts are extremely hot (temperature above 60°C/140°F).
- Cooking can only take place with the door closed, for safety reasons. If the door is opened, the oven stops temporarily and a message appears on the display. To resume cooking, simply close the door again.

- In order to maintain optimum performance, do NOT open the door during cooking, especially if you are using the microwave function. If it is not possible to avoid opening the door, please do so very slowly and carefully, paying attention to the hot steam coming out of the oven cavity.
- Wear appropriate protective thermal clothing and take great care when moving containers, accessories and other objects inside the oven cavity.
- Be extremely careful when removing trays from the oven cavity.
- Extract the probe from the core of the food before removing the trays from the oven, and place it in the external probe holder. Before extracting the tray, check that the probe cable is not in the way. Handle the probe with care because it is extremely sharp and, after use, can be very hot.
- During the COOL function (cavity cooling), the appliance supplies water and keeps the door closed to prevent injuries caused by hot steam.
- NEVER put any type of baking tray, hot or cold container, or other objects on top of the oven, even if it is turned off. DO NOT put highly flammable or heat-sensitive objects (e.g. plastic ornaments, lighters, etc.) near the appliance.
- Leave at least 10 cm of free space around the oven.
- The first time you use the appliance, some of the oils used for manufacturing may evaporate and produce fumes or unpleasant odours. These will gradually disappear as you continue to use the appliance.
- Liquids or other foods should not be reheated in sealed containers, as these may explode.
- To avoid burns, do not use containers filled with liquids or products that liquefy, heating up to higher levels than can be easily observed (IEC 60335-2-42: 2002 / AMDI: 2008)
- If reheating beverages, these may reach boiling point and cause a delayed eruption. Be careful when handling the container.
- The contents of any baby bottles and any baby food in jars must be mixed or shaken before consumption. Check the temperature to avoid scalding.
- Only use utensils and containers that are appropriate for the high temperature.
- Do not remove or touch the protective fan covering, the fans or the heating elements while the appliance is turned on and until they have completely cooled.
- Carefully read the product safety data sheet before handling and using the detergent.
- Do not open the oven door during washing as this could cause injury to eyes, mucous membranes and skin caused by contact with the cleaning chemicals used. These chemicals are sprayed by the rotor within the cooking chamber and moved by strong air currents.
- When carrying out maintenance on the oven water circuit, you must use PPE specific for the detergent (see the product safety data sheet). Specifically, gloves and goggles must be used since there could be detergent residue in parts of the circuit that could be pressurised.

- Do not tamper with the oven water circuit in any circumstances because this could cause damage, injury or death. The oven water circuit begins with a 3/4" connector, with a non-return valve built in, and includes all the subsequent piping and accessories.

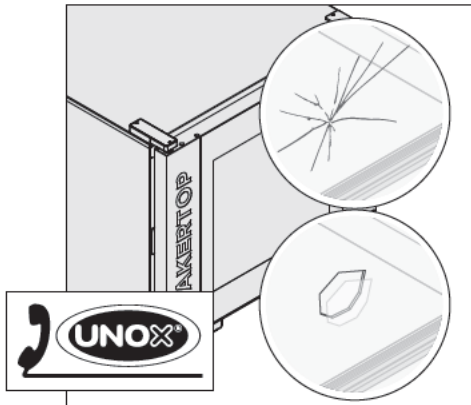

If the appliance glass is chipped or damaged, it must be replaced immediately by contacting an authorised support service centre. Do not use the oven. Risk of exploding glass.

ONLY FOR FREE-STANDING TROLLEY OVENS:

- Always lock the front wheel brakes after loading the oven cavity and at all times when they do not need to be moved.
- Always lock the trays into their guides.
- Be extremely careful when moving the trolley because the trays may contain hot fluids that may spill or the trolleys may fall over (for example if moved across uneven floors or through doors).

 **Risk of fire**

- Before using the appliance, make sure that there are no non-compliant objects (instruction manuals, plastic bags, etc.) or detergent residues inside the oven cavity. Also make sure that the flue is free of obstructions and that there are no flammable materials in the vicinity.
- When reheating food in plastic or paper containers, check the oven. Risk of fire.
- If you notice any smoke coming from the appliance, disconnect the appliance from the mains power supply and keep the door closed to extinguish any flames.
- Do not place sources of heat (e.g. grills, fryers, etc.), highly flammable substances or fuels (e.g. diesel, petrol, bottles of alcohol, etc.) near the appliance.
- The appliance must be cleaned daily, removing any food residue. Follow the detailed cleaning instructions on page **78**. Failure to carry out cleaning as indicated could cause the surfaces to deteriorate. This could reduce the life of the appliance and cause danger (if not removed, fats or food residue on the inside could catch fire).
- Do not clean the appliance with a steam or pressurised water jet.
- Do not use highly flammable food or liquids while cooking (e.g. alcohol).

 **Risk of electric shock!**

- Do not open the compartments marked with these symbols. Only qualified personnel authorised by UNOX may access these compartments. Failure to observe this regulation invalidates the warranty* and may cause damage or injury including death.

- Any routine maintenance procedure must be performed:
 - after disconnecting the appliance from the power supply and waiting for the capacitive components to discharge (approx. a few minutes);
 - after waiting for the appliance to cool down fully;
 - only if you are in good mental and physical condition, and are wearing suitable personal protective equipment (e.g. heat-resistant rubber gloves, eye protection, dust mask (optional), etc.).

ONLY FOR GAS OVENS

- Always keep the smoke exhaust pipe in the top portion of the oven free of obstructions (e.g. objects, trays, etc.).
- Always switch on the cooker hood when using the appliance if installed.
- If the appliance is connected to a flue, this must be:
 - kept free of any obstructions - risk of fire.
 - regularly cleaned and inspected as required by the relative standards for the country where it is used - risk of fire.
- The appliance must be installed away from air currents or drafts - risk of fire.
- Make sure that ventilation inlets and the underlying part of the appliance are clean and free of obstructions (e.g. objects near the appliance).
- If you can smell gas:
 - immediately shut-off the gas supply;
 - immediately ventilate the area;
 - do not turn on any electrical switches or create sparks or open flames;
 - use an external telephone to contact the gas utility company.

General information

Suggestions and warnings	10
Loading and using the trolleys (only for free-standing trolley ovens)	11
USB	12
Using the core probe	12
LCD control panel HOME screen	13
How to set values	16
UIP (UNOX INTELLIGENT PERFORMANCE)	17

SUGGESTIONS AND WARNINGS

 **Before using the appliance, read section “Safety regulations for use” carefully**

 **If cooking large amounts of greasy foods, place an empty tray without holes on the lowest grill rack in the oven. Alternatively, use an appropriately sized container.**

- When using the appliance for the first time, be sure to clean the inside of the oven cavity and the accessories thoroughly (see the **Maintenance** section on page **78**); let the oven run empty at maximum temperature for 1 hour to eliminate any unpleasant odours created by the protective grease used in the factory.
 - When the oven door is opened, unless the **“COOL”** function has been selected, heating and fan operation stops automatically. The built-in fan brake is activated (the fan continues to rotate for a short time only).
 - If the appliance is left running for more than 15 minutes without an operating or automatic cleaning mode being selected, stand-by is automatically activated to save energy.
 - To exit STAND-BY mode, tap the START/STOP button.
 - Use the appliance where the room temperature is between +5°C and +35°C.
 - Do not salt food inside the oven cavity. If this is not possible, clean the oven as soon as possible (see the **Maintenance** section on page **78**).
 - Beware of touching the external and internal parts of the oven during cooking and until it has completely cooled (it could reach temperatures above 60°C).
 - To prevent boiling, do not fill containers with liquids or foods that liquefy with heat in quantities exceeding those that can easily be kept under control.
-  For safety reasons, the last tray should NEVER be placed at a height greater than 160 cm. If it is necessary to do so, **apply the sticker contained in the “Starter Kit” at a height of 160 cm.**
- We recommend preheating the oven to compensate for the heat lost when opening the door; if SMART.Preheating is active, preheating will be managed automatically by the appliance (for further information, see p. **17**). If you prefer manual preheating, we

recommend setting the temperature to at least 30°C higher than the temperature required for cooking.

- In order to maintain optimum performance, **do NOT open the door during cooking**. If it is not possible to avoid opening the door, please do so very slowly and carefully, paying attention to the hot steam coming out of the oven cavity.
- Use the UNOX grills and trays. Try to distribute food uniformly on the trays and avoid overlapping foods or overloading the trays. Always respect the loading instructions for your appliance.
- Do not use highly flammable food or liquids while cooking (e.g. alcohol or wine).

Blackout

In the event of a blackout or shutdown, on restart the appliance will resume the program that was running previously (e.g. a Multi.time recipe). The duration of the cooking cycle may be extended by a maximum of 2 minutes.

When navigating and setting parameters only use your finger (which must be clean and dry); avoid using tools such as forks, spoons, etc. The pen provided must only be used for drawing the cooking curves on the Mind. Maps menu and for signatures.

LOADING AND USING THE TROLLEYS

(only for free-standing trolley ovens)

- ⊕ Use only UNOX trolleys, trays and grills.
Load the trolleys without overloading them: it is normal for the trolley to be pushed downwards and be lower in height, depending on how full the trays are. The trolley is loaded into the oven using the bottom trolley guides. Lock the trays into place when moving the trolley as shown in the figure. Always lock the front wheel brakes after loading the oven cavity and at all times when they do not need to be moved.

Be extremely careful when moving the trolley because the trays may contain hot fluids that may spill or the trolley itself may tip over (for example if moved across uneven floors or through doors).

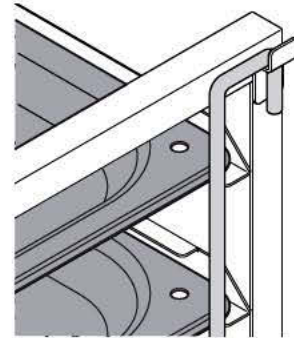
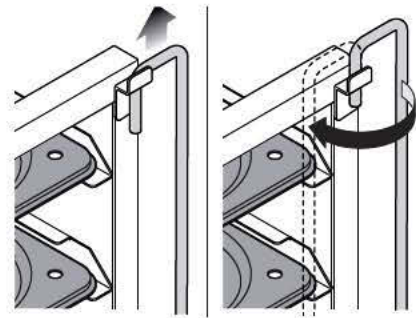

01

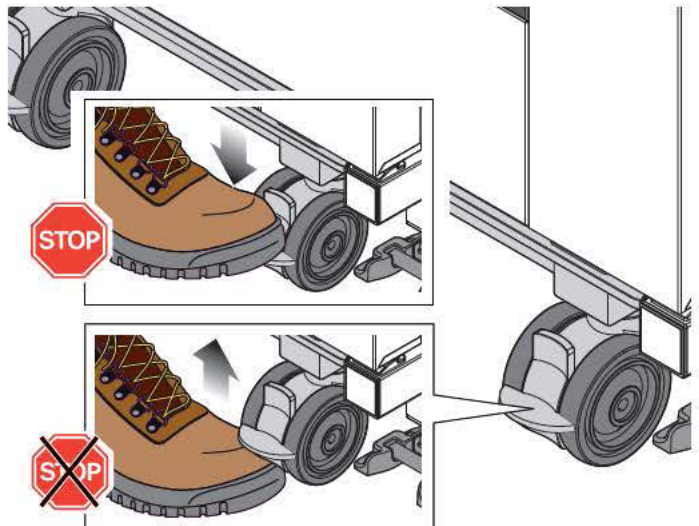

02



03

USB

04 ▶ The USB port is located below the LCD panel and allows you to import or export materials from your own USB stick (FT32 formatted and with capacity between 4 and 16 GB).

To manage the key ▶ p. 71.

USING THE CORE PROBE

05 ▶ During the cooking cycle, the probe detects the temperature at the core of the product. It reaches the temperature set by the user when the product is perfectly cooked both on the surface and on the inside. The core probe must be inserted deep into the food being cooked. The probe head must reach the product's "core" i.e. the innermost portion without piercing its way through the other side. If the food you are cooking is relatively thin, insert the probe parallel to the oven tray. When dealing with several foods, insert the probe into the smallest product; when this has reached the required core temperature (and therefore cooking is stopped) take the product out of the oven, insert the probe into the smallest remaining piece and restart the cooking cycle.

- + Handle the probe with care because it is extremely sharp and, after use, the needle is very hot.
- + Extract the probe from the core of the food before removing the trays from the oven, and place it in the external probe holder (never leave it dangling inside/outside the oven cavity).
- + Before removing the tray, check that the probe cable is not in the way.
- + Before starting the preheating of a program with the core probe, place it in the external probe holder

SWITCH THE APPLIANCE

06 ▶ The key switch the display on and off but do not power off the oven.

To switch off the oven, press the electrical panel switch to OFF.

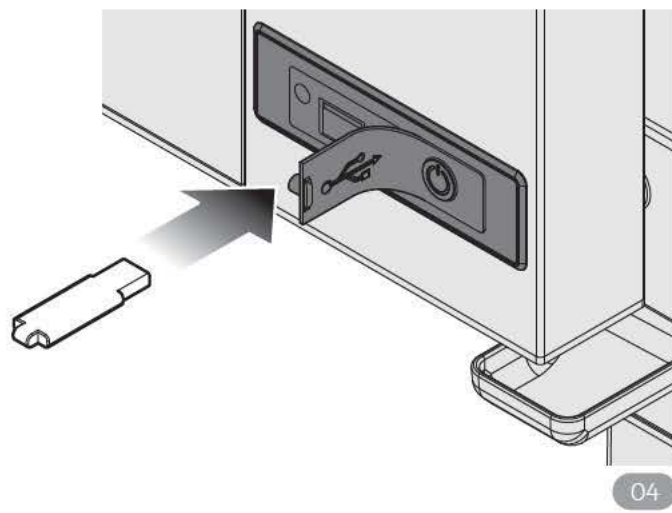
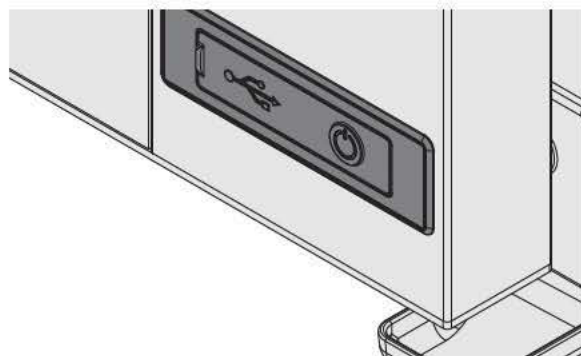

04

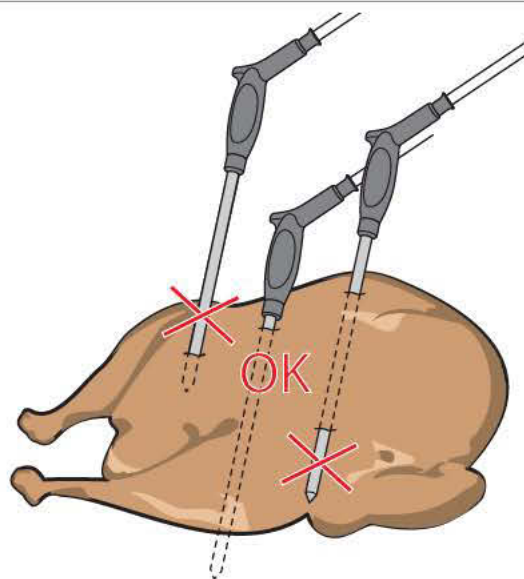

05

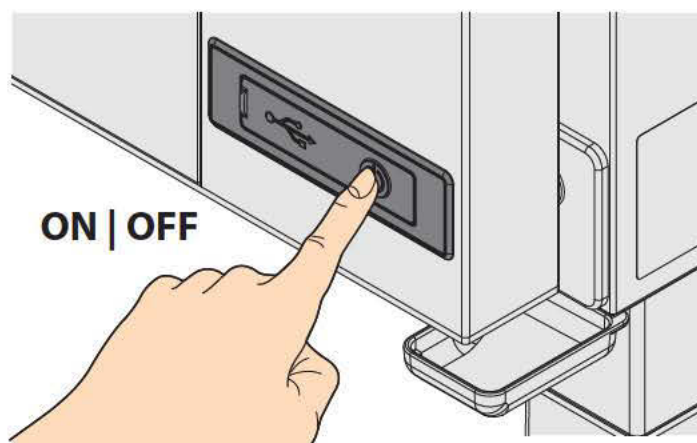

06

LCD CONTROL PANEL | HOME screen

The **"FAVORITES"** functions enables access to a list of recipes selected as "favourites" ▶ 07

The screenshot shows the home screen of the oven's LCD control panel. At the top, there are three navigation icons: a left arrow (Go back to the previous page), a star (Go back to main page), and a house icon (Go back to main page). Below these is the title 'CHEFTOP MIND.Maps™ PLUS' with a Wi-Fi icon. The main area contains a grid of function buttons: SET, MIND.MAPS, PROGRAMS, MULTI.TIME, CHEFUNOX, MISE EN PLACE, ROTOR.KLEAN, READY.COOK, and DDC STATS. At the bottom, there is a 'CHEFTOP SLOWTOP' button, a digital display showing '18:30' and '23/10/2017', and a 'START/STOP' button flanked by minus and plus signs. A callout points to the 'START/STOP' button, stating: 'The **START/STOP** button starts a cooking cycle'. Another callout points to the 'READY.COOK' button, stating: 'This oven allows you to control the connected accessories with one control panel (e.g. SLOWTOP). Tap the lower icon to use them.' A callout points to the 'SET' button, stating: 'See following page'. A callout points to the gear icon, stating: 'User parameter settings (date/time, unit of measurement, etc.) ▶ p. 68'. Callouts for the minus and plus signs indicate 'Decrease values' and 'Increase values' respectively.

Go back to the previous page

Go back to main page

See following page

User parameter settings (date/time, unit of measurement, etc.) ▶ p. 68

Decrease values

Increase values

This oven allows you to control the connected accessories with one control panel (e.g. SLOWTOP). Tap the lower icon to use them.

The **START/STOP** button starts a cooking cycle

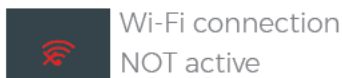
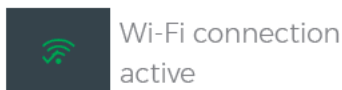



SET

This allows cooking cycles in which the user has to set the parameters manually for each cycle (e.g. temperature, cooking time, etc.).

+ More information ► p. 20



PROGRAMS

This menu provides access to a list of cooking cycles saved previously using the "set menu".

+ More information ► p. 38



MULTI.TIME

In the modern kitchen, needing to cook foods with different cooking times but in the same conditions (temperature, steam, etc.) simultaneously is not uncommon. With the "Multi.time" menu you can use the oven in a continuous cycle and set up to 10 timers that notify you when each dish is ready.

+ More information ► p. 42



CHEFUNOX

This menu offers a series of recipes preset by UNOX: the perfect end result, guaranteed.

+ More information ► p. 48



MISE EN PLACE

The "Mise en place" menu allows you to remove products with different cooking times, placed in the oven at different times, all at the same time.

+ More information ► p. 52



ROTOR.KLEAN

This provides access to a list of washes and lets you start the most suitable wash for your needs.

+ More information ► p. 58



READY.COOK/READY.BAKE

This is used to access some preset programs, to start certain cooking methods quickly.

+ More information ► p. 62



DDC STATS

This menu allows you to control consumption and HACCP data.

+ More information ► p. 64



A | Special function "FAVORITES"

07 ▶ The most frequently used recipes contained in the menus:
PROGRAMS | MULTI.TIME | CHEFUNOX

can be tagged as **"FAVORITE"** from the preheating screen (both classical and SMART)(points ① - ②).

Subsequently, by pressing the FAVORITES button (point ③), all recipes marked as such will be displayed: the function is particularly useful to easily find recipes that are frequently used.

To delete a recipe from the "FAVORITES" screen, hold down the icon for at least three seconds (point ④). A screen will appear that prompts to confirm the deletion (point ⑤): by selecting "YES" the recipe will be removed from the list.

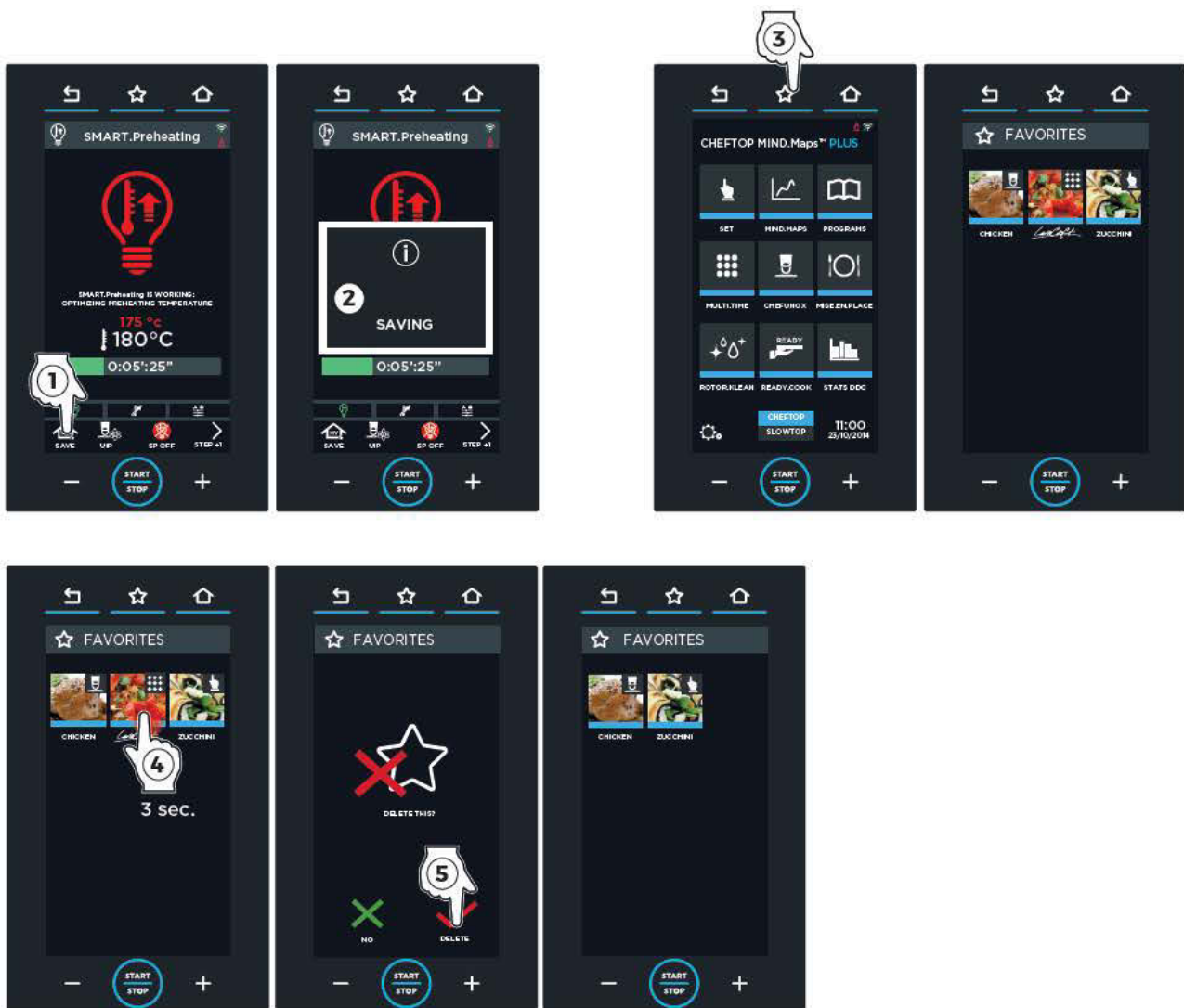

07

HOW TO SET VALUES

08 ▶ Drag the cursor

- ① Tap the symbol of the parameter to be set; this then changes colour (in the case of the "duration" parameter, tap hours, minutes or seconds separately).
- ② Tap the horizontal bar (this lights up) and drag the slider to the desired value; after three seconds of inactivity, the slider bar disappears.

09 ▶ Buttons

- ① Tap the symbol of the parameter to be set; this then changes colour (in the case of the "duration" parameter, tap hours, minutes or seconds separately).
- ② Use the **-** **+** buttons to modify the value.

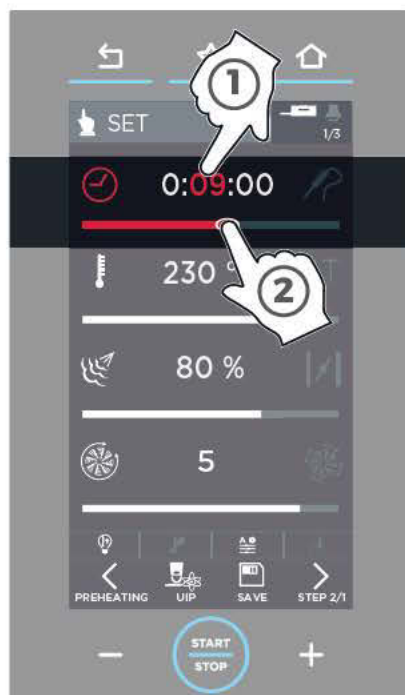

08

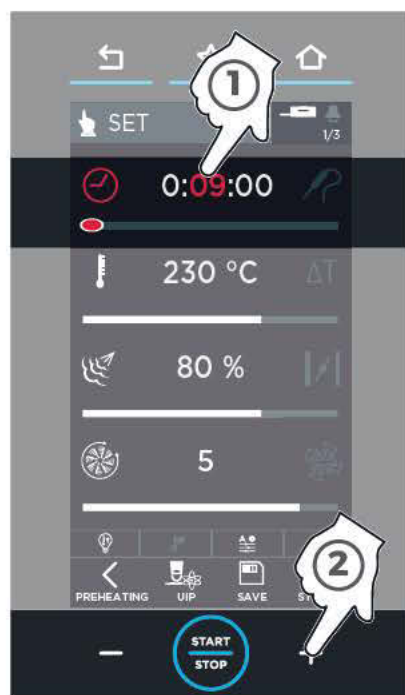

09

UIP (UNOX INTELLIGENT PERFORMANCE)



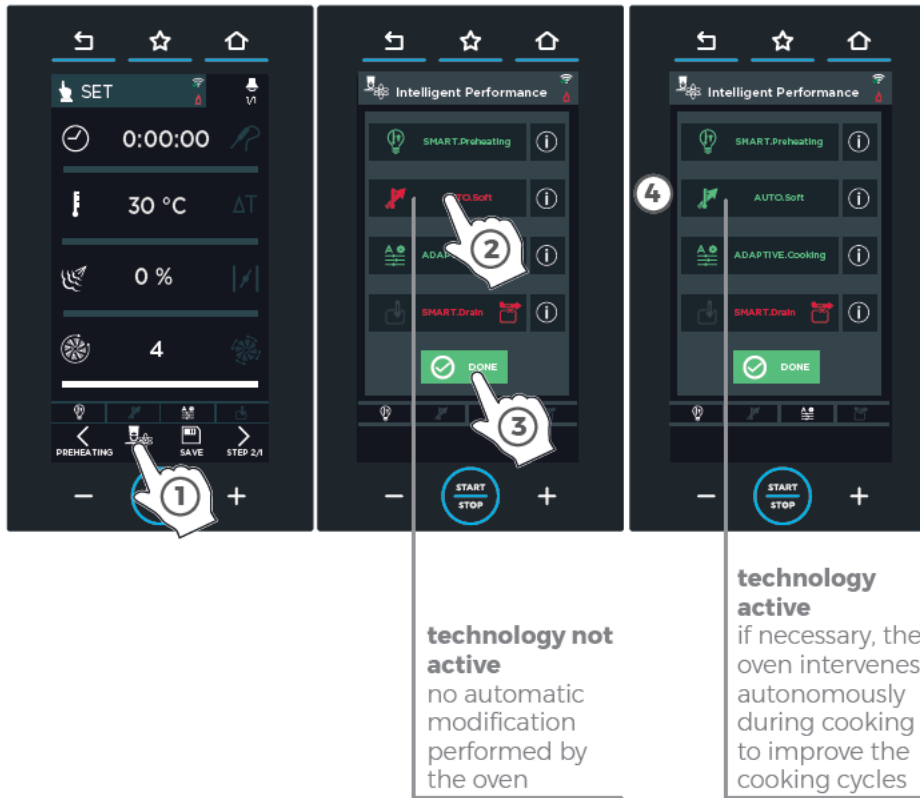

10 ► If activated, the UIP technologies allow the operator to constantly monitor each preheating and cooking process during manual cooking.

Thanks to this feature, the oven software is able to make **changes** to the user settings autonomously, where necessary, without the operator needing to intervene. This guarantees perfect results every time.



10

The following UIP technologies are available:

-  **SMART.Preheating** ► if activated, automatically adjusts the **preheating time and temperature** cycle time, to guarantee uniform cooking and energy efficiency.
-  **AUTO.Soft** ► if activated, automatically adjusts the **temperature increase speed** to improve cooking uniformity when cooking delicate foods.
-  **ADAPTIVE.Cooking** ► if activated, this function automatically optimises **all the cooking process parameters** according to the oven load, the time the door is open, and the readings from the oven sensors.
-  **SMART.Drain** ► this function associates the best position for the fat collection valve in the tank to the program. The program cannot be run if the valve is not positioned correctly. For information on managing the “Pollo” valve, please see the relevant manual.

11 ▶ When this key is pressed, information on the corresponding UIP technology is displayed

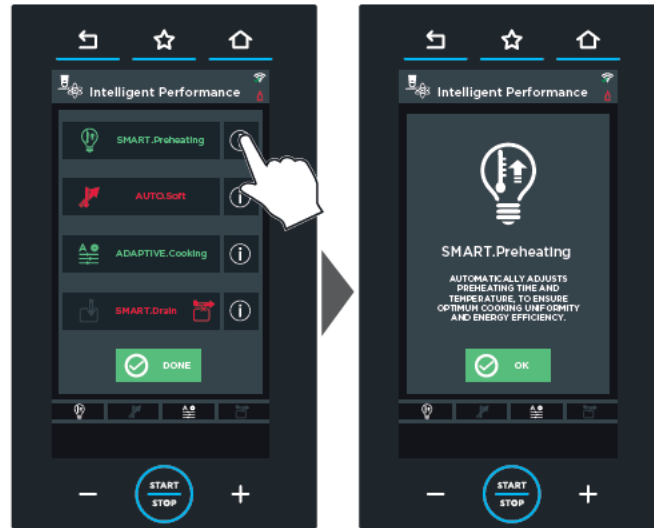

During a cooking cycle, the icons in the lower part of the oven provide useful information about UIP technologies

			GREY ICON ▶ the corresponding UIP function has NOT been activated and will not intervene to improve the cooking cycle
			GREEN ICON ▶ the corresponding UIP function has been activated and is currently in operation for this cooking cycle
			WHITE ICON ▶ the corresponding UIP function has been activated and is currently NOT in operation for this cooking cycle

Use | SET menu



Preheating	22
Setting cooking steps	23
Starting the cooking cycle directly without saving it	26
Save and start the set cooking cycle	27
Cooking cycle in progress	31
Cooking end	32

For manual cooking, based on experience, you must set the following parameters for preheating and each cooking step:

- **cooking time** or **core temperature** (the two parameters reciprocally exclude each other);
- **temperature in oven cavity** or **Delta "T"** (each of these parameters reciprocally excludes the other);
- **steam input/extraction** in the cavity;
- **fan speed**.

Each manual cooking cycle is always composed of:

- ► p. 22 | an automatic **preheating**, manual setting or SMART. Preheating cycle (recommended mode);
- ► p. 23 | **up to nine steps** for cooking, each with its own cooking parameters. The appliance automatically passes from one cooking step to the next, if present. Here is an example:



Example of cooking cycle involving more than one step, where some are timed and others use the core probe. Step 3-9 are not needed and therefore have not been set.

After having set all the parameters (time, temperature, etc.), it is possible to **directly start cooking without saving** ► p. 26 or **save the recipe and then start the cooking cycle** ► p. 27.

Hyper Smoker

the icon only appears if the optional smoker is installed. For information on using the hyper smoker accessory, please see the relevant manual.

Cooking time

(from 0 minutes to 9h:59min:59sec then INDEFINITE, i.e. the oven operates continuously)

Temperature in oven cavity

(from 30°C to 260°C).

STEAM.Maxi™

Steam input to cavity

Normal fan speed or, if installed,

Hyper Smoker: select the thickness of wood

The icons show which UIP functions are active

access the preheating settings or go back to the previous step

UIP technologies

For more details, see p. 17

Start the set cooking cycle

Special optional "PRESSURE STEAM" function

For more details, see p. 25

By activating the MULTI.Product function, at the end of the step, an image and a note entered by the user will be displayed (e.g. "add oil").

For more details, see p. 24

STEP

This icon shows the number of steps being set.

Core temperature

Setting the target core temperature

For more details, see p. 12

Delta "T" temperature

(from 0°C to 120°C)
Temp. in cavity/Core temp. = Temp. Delta "T"

DRY.Maxi™

steam extraction from cavity

Pulsed air flow speed (the fan turns off when the oven has reached the temperature) or, if installed,

Hyper Smoker: select the thickness of wood

Set steps 1 to 9

Save the parameters set

For more details, see p. 27

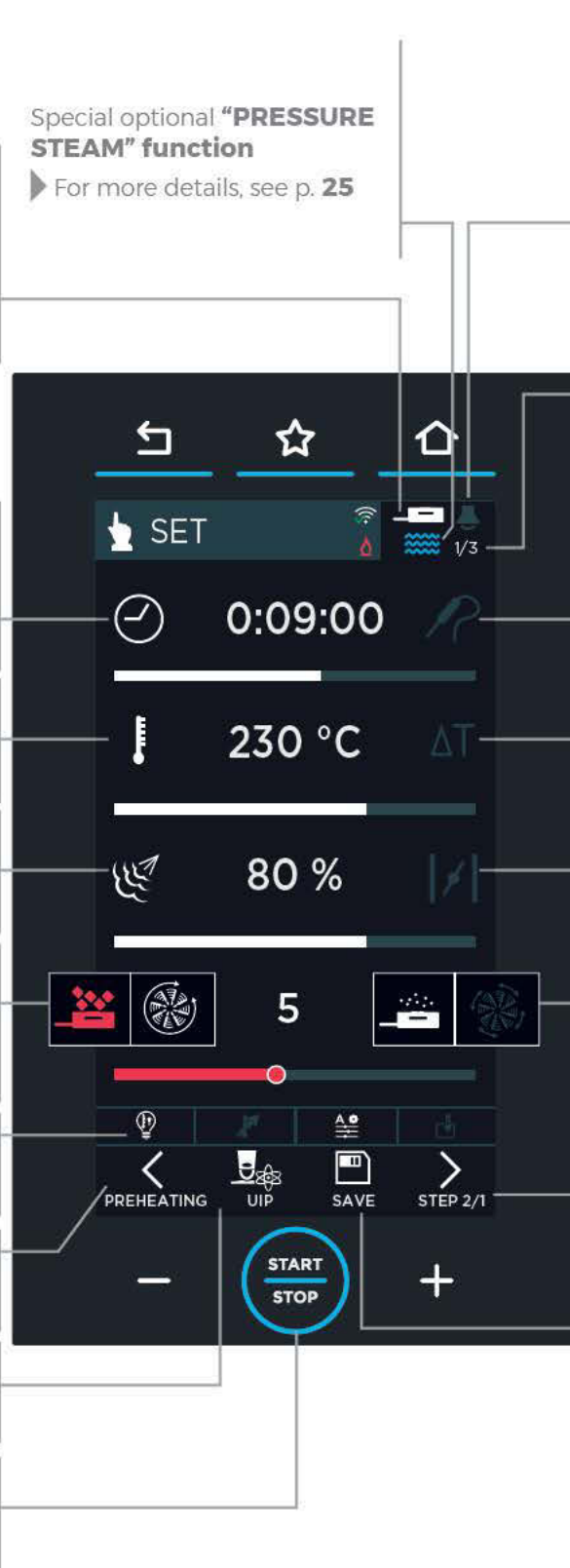

PREHEATING

Most cooking requires preheating which is optional but is always recommended to achieve the best cooking results.

Preheating can be set in two ways:

- using UIP technologies and activating **SMART.Preheating** (recommended mode) ▶ preheating is managed by the appliance automatically;
- in **manual mode** ▶ the preheating temperature must be set manually.

Once the cooking cycle has been started and regardless of the mode selected, it is possible to interrupt the preheating stage at any time (if needed) and move to STEP 1 ▶ p. 31

13 ▶ Activate SMART.Preheating (recommended mode)

By activating the SMART.Preheating function, preheating is managed by the appliance automatically ▶ For more details on UIP technology, see p. 17.

14 ▶ Setting preheating in manual mode

- ① Tap the "PREHEATING" icon: the settings screen appears.
- ② Set the preheating parameters:
 - **time** ▶ if a time is entered, once the set temperature is reached, the oven holds the temperature for the time set rather than starting the next step (STEP 1);
 - **temperature** ▶ it is always better to preheat the oven to a temperature at least 30-50°C higher than the temperature required for cooking, in order to reduce the effects of heat lost when opening the door.
- ③ Go to the settings for STEP 1. To enable use, a cooking cycle must contain at least one step.



SMART.Preheating

13



Manual preheating

14

SETTING COOKING STEPS

15 ▶ Set one or more than one cooking steps

① Set, according to need:

- the **cooking time** (from 0 minutes to 9h:59min:59sec then INDEFINITE, i.e. the oven operates continuously) or the **core probe temperature** ▶ p. 12: each of these parameters reciprocally excludes the other.

In the first case (time), the cooking cycle ends after the set time; in the second case (core probe), the cooking cycle ends when the set core temperature is reached.

- the **cooking temperature** (from 30°C to 260°C). For particularly delicate cooking cycles, the Delta "T" function can be used as an alternative (from 0°C to 120°C). In this case, you need to insert a core probe into the core of the food.

By definition, Delta T maintains the cavity temperature at a constant difference from the core probe temperature, using the formula: Oven cavity temperature minus Temperature of the core probe. Delta T can only be used setting a core probe temperature goal, not with time. Example: if Delta T= 80°C and goal core probe temperature is 70°C, the cooking ends when the temperature of the probe reaches 70°C. The cavity temperature would then be 150°C (because 150°C-70°C=80°C)

- the **steam** released into (**STEAM.Maxi™**) or **removed from** (**DRY.Maxi™**) the oven cavity;
- the **fan speed**: normal or pulsed (left and right respectively; the fan turns off when the oven has reached the temperature).
- function MULTI.Product** ▶ For more details, see p. 24

② For perfect results every time, you can use UIP technology ▶ for details go to p. 17

③ If necessary, set up to nine other cooking steps in the same way. Each can be characterised by different cooking parameters. The appliance automatically passes from one cooking step to the next, if present.

After having set all the parameters (time, temperature, etc.), you can:

- start the cooking cycle directly without saving it** ▶ p. 26
in this case the parameters set are not saved and must be entered during each subsequent cooking cycle;
- save the set recipe and then start a cooking cycle** ▶ p. 27
this means that the recipe can be used later, at any time, without having to reset the parameters each time.



example of setting the parameters (STEPS from 3 to 9 not used)

B | Special function MULTI.Product



The MULTI.Product function lets you select a **photo** and write a **note** which will appear at the end of the step for which the function has been activated.

- ① By using the arrows \leftarrow and \rightarrow you can see the step at the end of which you want the screen with the note to be displayed (e.g. STEP 1). Tap the white icon.
- ② ③ Select the photo you want to appear.
- ④ ⑤ ⑥ Write the note, e.g. "Add oil".
- ⑦ Confirm with "OK".
- ⑧ The icon will now turn green indicating that the function is active for STEP 1.
- ⑨ At the end of STEP 1, the set screen will appear.



C | Special function optional Pressure Steam

With the **Pressure Steam** function it is possible to cook plates that require large quantities of steam (e.g. Jiaozi - Chinese Dumplings).

- ① Activate the function by pressing the corresponding icon: this will go from grey to blue. Each cooking step is independent, i.e. there can be steps with the function activated, others with the function disabled because it is not necessary: in this last case, to disable the function simply press the corresponding icon (grey icon = function NOT active)
- ② A screen with pre-set parameters appears:
 - 80°C preheating
 - 12 minutes cooking time
 - 100°C cooking temperature
 - 120% maximum humidity
 These values can be changed as needed as described in the section dedicated to manual cooking but we advice to leave them as they are and adjust only the time if needed.
- ③ Then, set all the steps you need.
For further details on the setting of steps ► p. **23**.
- ④ Then, start the cooking by pressing the **START/STOP button**.

Each cooking step is independent, i.e. there can be steps with the function activated, others with the function disabled because it is not necessary.



STARTING THE COOKING CYCLE DIRECTLY WITHOUT SAVING IT

16 ▶ To start the cooking cycle immediately, tap **START/STOP**; in this case the parameters set are not saved and must be entered during each subsequent cooking cycle.

Then go to p. 31.

+ At the end of the set time, the recipe can be saved by pressing "SAVE", see fig. ▶ 24.

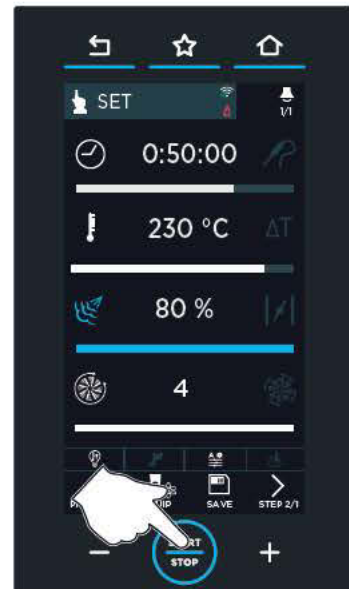

16

D | Further information

Measuring consumption



From the cooking end screen, click on the  button to display the electricity and water consumption data, as well as the HACCP data.

Screen locking



Screen locked

If the oven door is opened, the screen to the side indicates that it is not possible to use the display for safety reasons.

When the door is closed or after pressing and holding the "HOME" button, the screen can be used again.

To deactivate the lock, access the USER SETTINGS menu (see p. 58).

SAVE AND START THE SET COOKING CYCLE

Saving a cooking cycle means that it can be used later, at any time, without having to reset the parameters each time.

The cooking cycle can be saved:

- **immediately after having set the cooking parameters** (time, temperature, etc.). In this case, you can start it by pressing **START/STOP**;
- **at the end of the cooking cycle**, by pressing "SAVE", see fig. 24.

17 ▶ To save the recipe which has just been set:

① press "SAVE".

18 ▶ The screen will show:

② assign a **name** to the recipe (e.g. CROISSANT);

③ tap on the camera symbol to select a **picture** for the program;

④ assign a **tray** to the recipe, selecting from those available; navigate through the different groups of pictures with the arrows on the bottom on the page.

⑤ Press "SAVE" per save a cooking cycle with the set parameters (name, photo, etc);

⑥ tap the **position** where you want to save the cooking cycle (e.g. under "BEIGNET"). If a position already occupied is selected, the program requests authorisation to overwrite the recipe.

At the bottom of the screen:

- the arrows < and > are used to scroll through the 16 **groups** available;
- the arrows v and ^ are used to scroll through the 16 **positions** available in the group.

The cooking cycle will be saved with the settings entered.

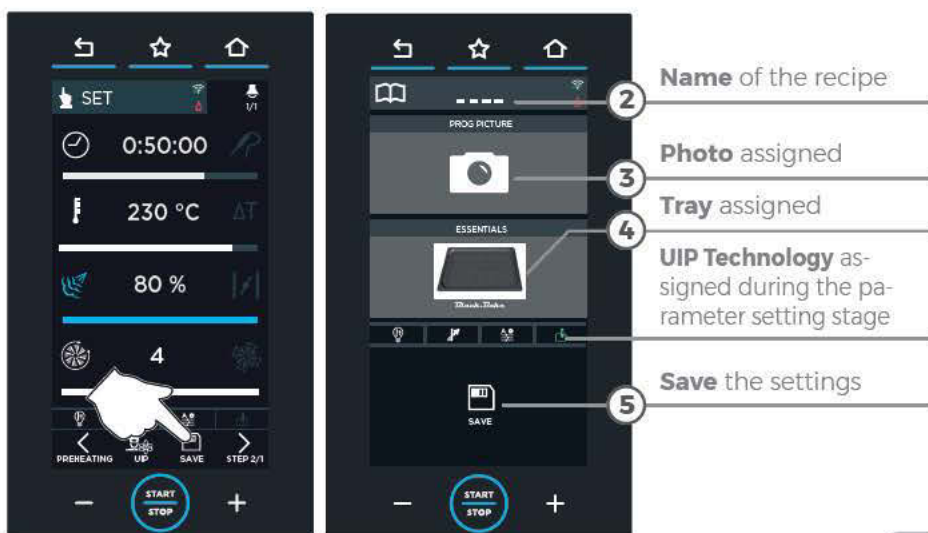

17

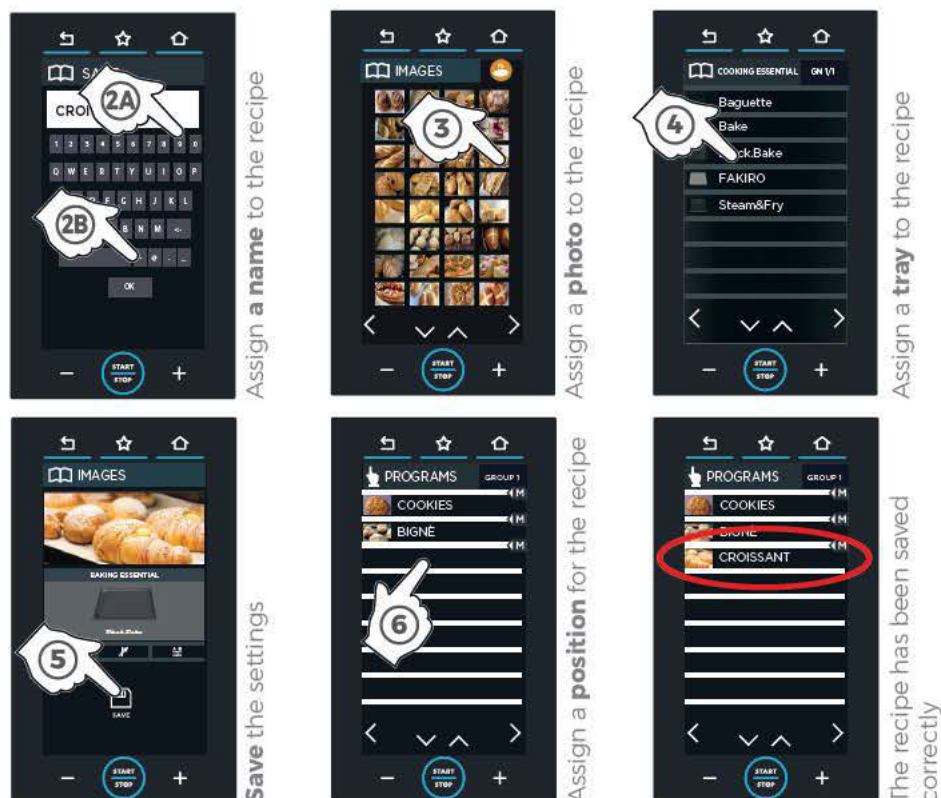

18

- 19 ▶ Tap one of the cooking cycles listed to open the screen that enables you to:
- ① **display/modify** the parameters of the saved cooking cycle;
 - ② **copy** the cooking cycle (to create one with similar parameters);
 - ③ **delete** a saved cooking cycle: in this case the system requests confirmation before permanently deleting the item;
 - ④ **start** a cooking cycle with the **START/STOP** button.

delete the recipe

display/modify the parameters of the saved cooking cycle

copy the cooking cycle

start the cooking cycle

if you decide to delete the recipe ③ DELETE, a screen will request confirmation before permanently deleting the item

WHAT HAPPENS AFTER A COOKING CYCLE IS STARTED?

After starting a cooking cycle, there are three possible situations depending on the settings which have been entered previously:

- ▶ p. 28 | **preheating or cooling of the cavity not required;**
- ▶ p. 29 | **automatic or manual preheating, or SMART.Preheating starts;**
- ▶ p. 30 | **cavity cooling starts.**

20 ▶ Preheating or cooling of the cavity not required

If the oven is already at the optimum temperature for the set or selected program at the start of a cooking cycle, the oven will not preheat or cool the cavity. Instead, a screen will appear to the side prompting you to put the dishes in the oven directly. After this operation, when the oven door is closed, the relevant steps automatically start ▶ p. 31.



21 ▶ Automatic or manual preheating, or SMART.Preheating

Preheating always starts if the oven cavity is at a lower temperature than the temperature set for the first step of the cooking cycle.

If during the parameter setting phase:

- NEITHER manual NOR SMART.Preheating has been set, **automatic preheating** of the cavity will start in any case and will end when the temperature set for step 1 is reached;
- **manual** preheating has been set or **SMART.Preheating** has been activated, it will end either when the temperature set by the user has been reached (manual preheating) or automatically, when managed by the oven software (SMART.Preheating).

In both cases, do not put the dishes into the oven immediately, but wait until this first step ends. This will be indicated by a buzzer and the relative screen.

After this operation, when the oven door is closed, the relevant steps automatically start ▶ p. 31.

⊕ If needed, it is always possible to interrupt a preheating in progress and move directly to the first step; however, once the preheating has been interrupted, it can NOT be reactivated.

To interrupt the preheating function:

- manual ▶ press  SKIP PRE.
- SMART.Preheating ▶ press  S.P. OFF to move to manual preheating and then press  SKIP PRE. to lock it.

⊕ It is NOT possible to change a manual preheating cycle which is in progress with a SMART.Preheating cycle.

▶ automatic or manual preheating function

Estimated time until the end of the preheating added to the total cooking time

Preheating time set. This can be modified directly from the screen

Oven cavity temperature

Set temperature

Access the UIP technology setting ▶ For more details, see p. 17

Skips preheating and starts the cooking cycle immediately

Access to the parameters for the subsequent steps



The screen indicates that preheating has completed; put the dishes into the oven.

▶ SMART.Preheating

Oven cavity temperature

Set temperature

Time remaining before the end of preheating (presumed) or progressive percentage

Access the UIP technology setting ▶ For more details, see p. 17

Change from preheating with SMART.Preheating in progress to manual preheating

Access to the parameters for the subsequent steps



22 ▶ **Manual cooling or SMART.Preheating**

If the actual temperature detected in the cavity is higher than the set temperature (for example because the oven has recently finished cooking at a much higher temperature than required preheated temperature), the oven will start to cool the cavity using the fans.

To speed up the operation, a screen will prompt you to open the door (it is normal for the fans to continue to operate even when the door is open).

Wait for this to end before putting the food in the oven. After this operation, when the oven door is closed, the relevant steps automatically start ▶ **p. 31**.

▶ **manual cooling**

Estimated time until the end of the cooling cycle added to the total cooking time

Time remaining until the end of the cooling cycle (estimated)

Oven cavity temperature

Set temperature

Change from the manual cooling in progress to SMART.Preheating

Skip cooling and start the cooking cycle

Access to the parameters for the subsequent steps

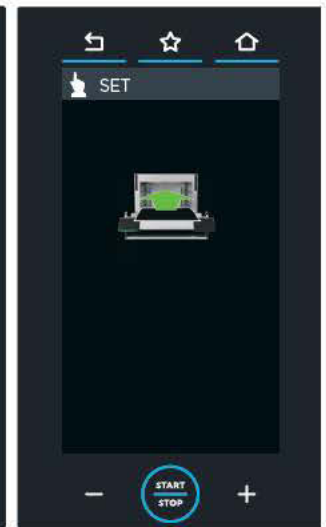
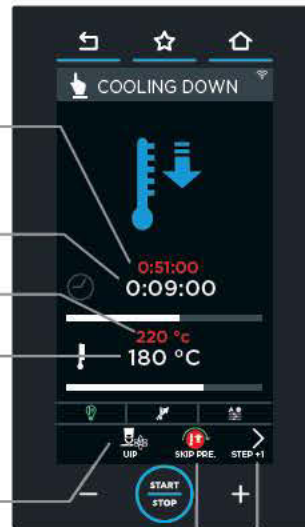

The screen indicates that preheating has completed; put the dishes into the oven.

▶ **SMART.Preheating cooling**

Oven cavity temperature

Set temperature

Time remaining until the end of the cooling cycle (presumed) or progressive percentage

Access the UIP technology setting

Change from cooling with SMART.Preheating in progress to manual cooling

Access to the parameters for the subsequent steps



COOKING CYCLE IN PROGRESS

23 ► Cooking is in progress. If you want to stop the cooking cycle in progress, hold down the **START/STOP** (approx. 4-5 seconds).

steps have been set using the **duration time** method

cooking end time (in this example, the dishes will be ready at 11:48)

Time remaining until the end of the cooking cycle in progress

Current cooking cycle time remaining > 15 sec.

Current cooking cycle time remaining < 15 sec.

Cooking complete time remaining < 5 sec.

Time remaining until the end of the current step

Displays and allows the temporary modification of the parameters of the recipe in progress



From this screen, you can **make temporary changes** to the cooking cycle in progress

steps have been set using the **core probe** method

Time remaining until the end of the cooking cycle in progress

cooking end time (in this example, the dishes will be ready at 11:48)

Current cooking cycle time remaining > 15 sec.

Current cooking cycle time remaining < 15 sec.

Cooking complete time remaining < 5 sec.

Time remaining until the end of the current step

Displays and allows the temporary modification of the parameters of the recipe in progress



From this screen, you can **make temporary changes** to the cooking cycle in progress

Probe temperature current
Core probe temperature set



GREY ICON ► the corresponding UIP function has NOT been activated and will not intervene to improve the cooking cycle



GREEN ICON ► the corresponding UIP function has been activated and is currently in operation for this cooking cycle



WHITE ICON ► the corresponding UIP function has been activated and is currently NOT in operation for this cooking cycle

COOKING END

24 ► Cooking ends when the **set time interval** or **core probe temperature** is reached; the end of cooking is indicated by a long beep and the relevant screen showing to the side.

From this screen you can:

- 1 **save** the completed cooking cycle (if this has not already been done)
- 2 **repeat the cooking cycle** as soon as it has finished, modifying the parameters if necessary;
- 3 **repeat the last step** carried out, modifying the parameters if necessary.
- 4 **repeat the last step** of the cycle after moving the core probe to another portion;
- 5 **repeat the last set step**, modifying the core probe temperature.

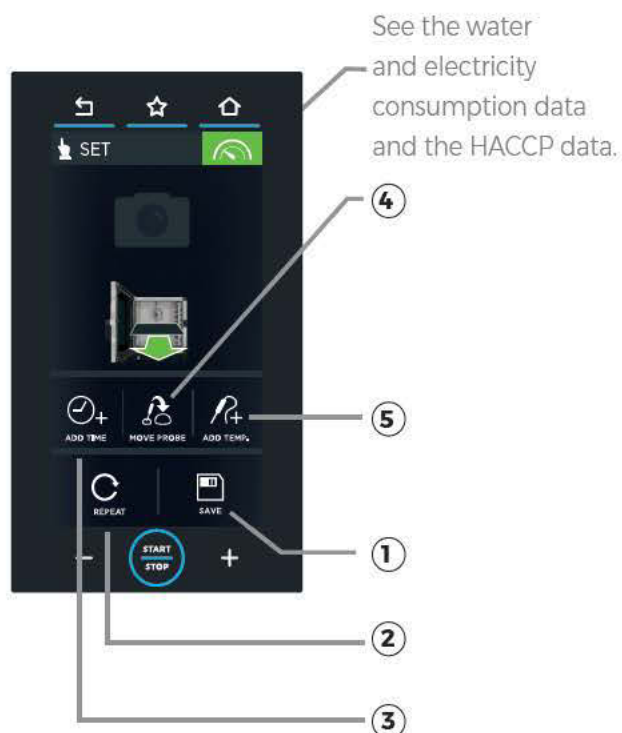

24



If you do not want to save the cooking cycle, press **“home”** to return to the main page.

25

Use | MIND.Maps menu



How MIND.Maps works	34
Set the MIND.Maps curve	35
Subsequent parameters and saving the curve	36
Start the cooking cycle set	37

A new simple, quick and intuitive way to set cooking parameters. This menu allows you to set a parametric curve that controls the temperature, steam extraction/introduction and the fan speed in the cavity at all times.

Only the stylus supplied can be used to set this curve.

HOW MIND.Maps WORKS

26 ▶ In the example, a MIND.Maps screen is shown. The vertical **axis (Y)** shows the parameters to be set (e.g. temperature, steam input or extraction, fan speed, etc.), while the **horizontal axis (X)** shows the ⌚ time or 🍷 core probe temperature.

By drawing a curve with the stylus you can modify a parameter (e.g. temperature) over time, minute by minute, giving you maximum flexibility and control.

26 ▶ Example shows the temperature being set based on the time:
- at 5 minutes, the temperature is set to 230°C,
- at 15 minutes the temperature should decrease to 135°C and so on.

You can also choose to use the UNOX INTELLIGENT PERFORMANCE (UIP) technology by clicking on the relevant symbol.

📄 For more details, see ▶ p. 17

SET THE MIND.Maps CURVE

26 ▶ How to draw a MIND.Maps curve

- 1 Tap the icon "NEW mind map".
- 2 Use the stylus to draw the required curve.
The symbol  enables access to curve settings at over 25 minutes.

27 ▶ Changes to the MIND.Maps curve

- 1 To **change** a part of a curve that has already been drawn, click on the curve with the stylus and, while continuing to hold it, modify the curve as desired.
- 2 To **delete** parts of a curve that has already been drawn, repeatedly click on the red "X" on the left.

28 ▶ Inserting guide rulers

- 1 To **insert rulers** that help view the values, click on the X axis in the desired position (in the example: 5 and 15 minutes): the numbers will be highlighted in grey and a green ruler will appear. The numbers above the rulers (in the example "10") show the difference in minutes compared to the previous ruler (15 minus 5 minutes = 10).
- 2 To **delete rulers**, with the numbers highlighted in grey, repeatedly click on the red "X" on the left: the rulers will be deleted in the order they were created.

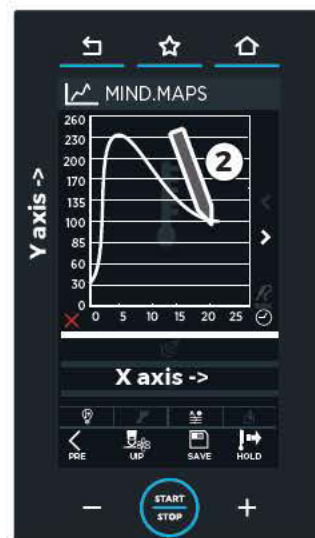
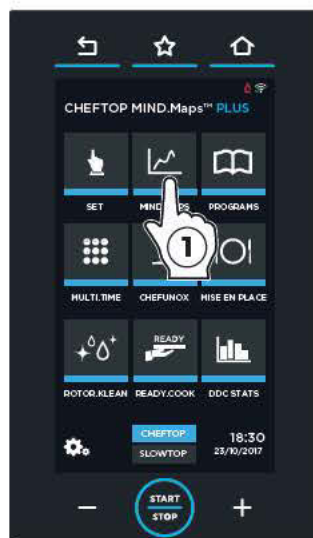

26

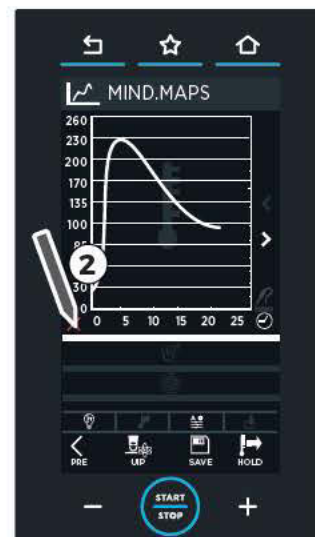

27

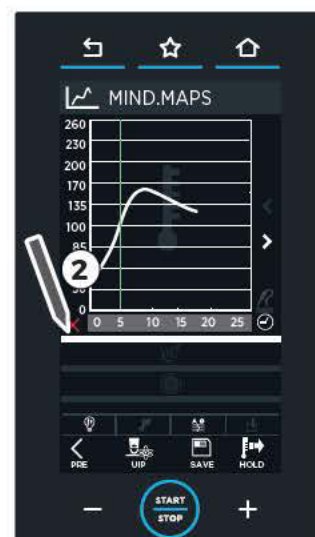

28

29 ► Zoom

- ① To **enlarge** an interval, click on the Y axis in the desired position (in the example: an interval between 170° and 200°).
- ② Click in the Y axis again or on the symbol in the bottom left corner to return to the normal mode.

SUBSEQUENT PARAMETERS AND SAVING THE CURVE

- 30 ► ① Tap another icon to set the next parameters, **steam extraction (DRY.Maxi)** or **steam input (STEAM.Maxi)**, and **fan speed**.

- ② Trace a new curve to set the selected parameter:

- DRY.Maxi** or **STEAM.Maxi**:
- the extraction values are displayed in RED,
 - the input values are displayed in BLUE;

fan speed (from speed 1 - minimum, to speed 4 - maximum):

- the pulsating fan speed is shown with a dashed line (values below zero),
- the normal speed is shown with a continuous line (values above zero).

The thickness of the line also indicates the speed (a thin line shows a slow speed and a thick line shows a high speed).

- ③ To set preheating, press the **"PREHEATING"** button at the bottom right and set this step.

- ④ Press the **"SAVE"** button to save the set curve; the saving process is the same as that explained previously under **"set menu"**.

For more details, see ► p. 20

The "HOLD" button at the bottom right means the oven can be used continuously.

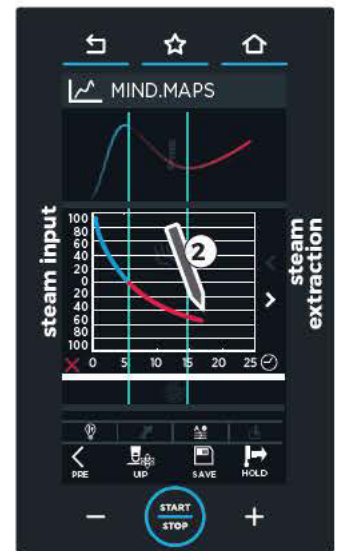
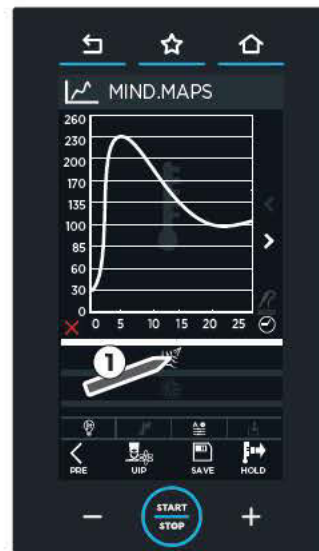
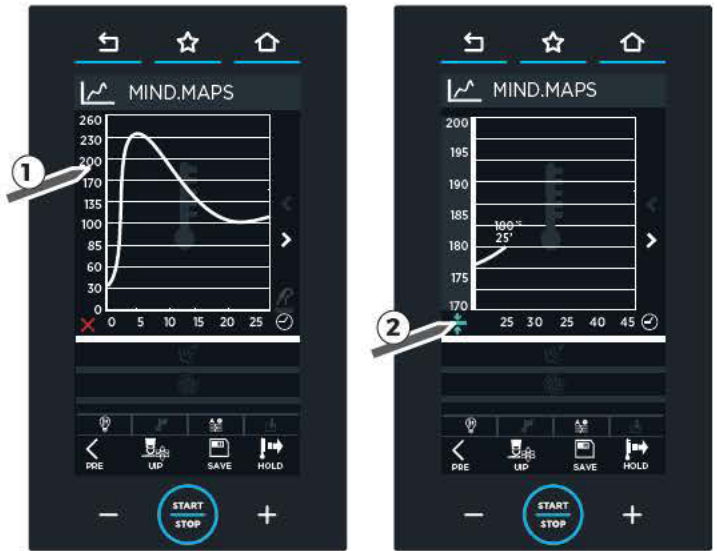

steam extraction/input

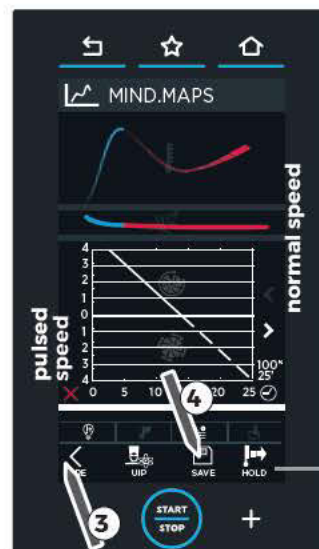

HOLD: the oven operates continuously

START THE COOKING CYCLE SET

31 ▶ Press the **START/STOP** button: if a **preheating** cycle has been set for the cooking cycle, the screens shown standard or SMART.Preheating ▶ p. 28.

When the set temperature is reached, a beep notifies the user that the preheating step has finished and an icon appears to indicate that the food should be put in the oven.

After, step 1 is started up automatically as soon as the oven door is closed.

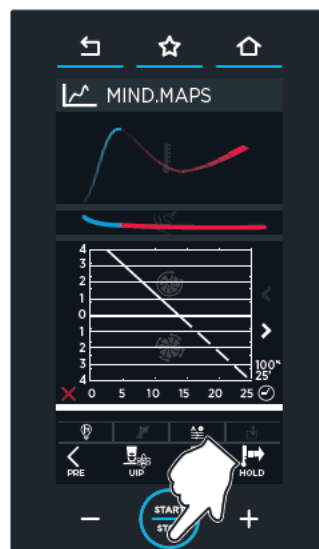

Use | PROGRAMS menu



MY PROGRAMS	38
MY MIND.MAPS	40

This menu enables access to a list of cooking cycles saved previously.





MY PROGRAMS

In this section the user can recall a previously saved cooking cycle by using the **“SET menu”**.

 For more details, see ► p. 20

32 ► ① Tap the **“programs”** icon;

② tap the **“MY PROGRAMS”** icon: a list of cooking cycles previously saved using the **“SET menu”** opens.

③ Tap one of the cooking cycles listed. At the bottom of the screen, the arrows  and  are used to scroll through the various cooking cycles saved in the group, while arrows  and  are used for scrolling through the 16 groups available.

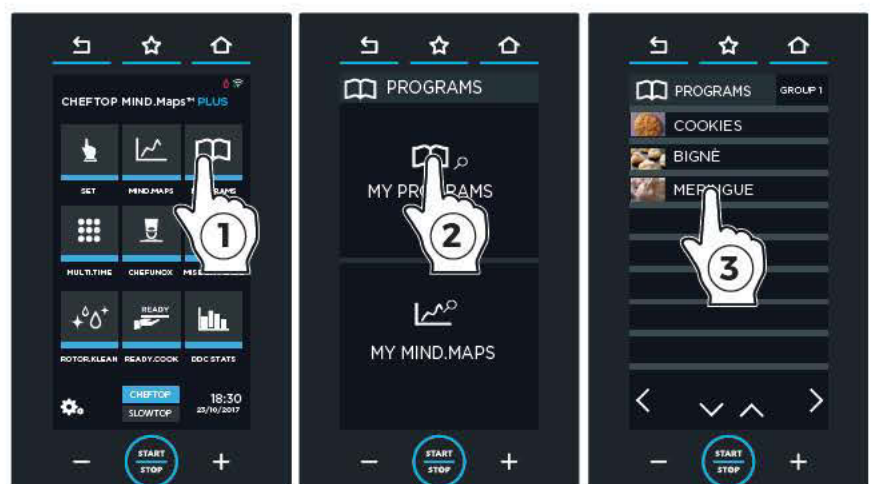

- 33 ▶ 4 From this screen you can:
- A view/modify the saved cooking cycle;
 - B duplicate the cooking cycle (to create one with similar parameters);
 - C delete a saved cooking cycle: in this case the system requests confirmation before permanently deleting the item.

5 To start the cooking cycle, press the **START/STOP**.

The following will then start automatically:

standard or SMART.Preheating (where relevant):

wait for this to end before putting the food in the oven

cooling the cavity (if the temperature in the cavity is higher than the set temperature e.g. because the oven has been operating continuously): wait for the end of this phase before putting the food in the oven;

cooking with the parameters that have just been set: in this case, it means that no preheating has been set, so you need to put the food in the oven straight away.

For more details, see ▶ p. 28

34 ▶ The most frequently used recipes can be tagged as **"FAVORITE"** from the preheating screen (both classical and SMART) see ▶ p. 15

35 ▶ When completed, a screen will prompt the user to change or repeat the recipe.

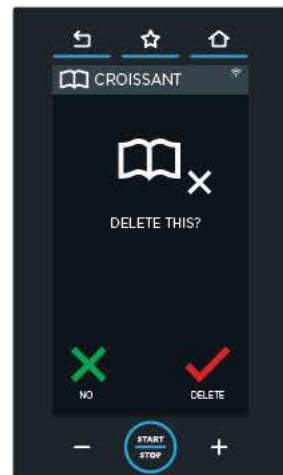

if you decide to delete the recipe, a screen will request confirmation before permanently deleting the item

33

save the cooking cycle as **"FAVORITE"** see ▶ p. 15

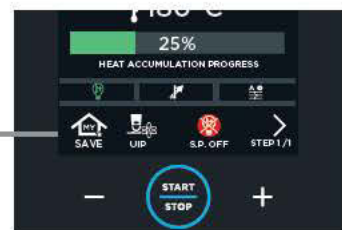

34



duplicate the cooking cycle (to create one with similar parameters)

delete a saved cooking cycle: in this case the system requests confirmation before permanently deleting the item

repeat the cooking cycle that has just been completed keeping the same parameters

view/modify the saved cooking cycle

35





MY MIND.MAPS

In this section the user can recall a previously saved cooking cycle by using the **"MIND.MAPS menu"**.

For more details, see ► p. 42

36 ► ① Tap the **"programs"** icon;

② tap the **"MY MIND.MAPS"** icon: a list of cooking cycles previously saved using the **"MIND.MAPS menu"** opens.

③ Tap one of the cooking cycles listed. At the bottom of the screen, the arrows  and  are used to scroll through the various cooking cycles saved in the group, while arrows  and  are used for scrolling through the 16 groups available.

④ and ⑤: see previous page.



Use | MULTI.TIME menu

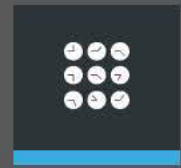

NEW MULTI.TIME	43
MY MULTI.TIME	45
MY MENU	46

In the modern kitchen, needing to cook foods with different cooking times but in the same conditions (temperature, steam, etc.) simultaneously is not uncommon. With the “MULTI.TIME” menu you can use the oven in a continuous cycle and set up to 10 timers that notify you when each dish is ready.

Using this function, the **oven maintains the set temperature and clima set indefinitely.**

37 ▶ The example to the side shows that **3 trays containing different foods are inserted** into the oven cavity at **10:00, 10:15 and 10:18.**

For each tray, a timer is set with a different end time, as each foodstuff requires a specific cooking time:

⌚ 30 minutes | 45 minutes | 2 hours

We recommend using timer 1 for the tray at the top of the oven, timer 2 for the tray below and so on. This helps the user to know which tray needs to be taken out when the timer expires (for example, when timer 2 expires, take out the second tray down).

When a timer expires (in the example the first timer to expire will be the one for TRAY 1, **10:30**), a beep notifies the user that the corresponding tray needs to be taken out. When the door is opened and closed, the expired timer is reset.

A maximum of 10 timers can be set (corresponding to a maximum of 10 different foods being cooked at the same time).

pos.1 (timer 1)
pos.2 (timer 2)
pos.3 (timer 3)
pos.4 (timer 4)
pos.5 (timer 5)
pos.6 (timer 6)

TRAY 1
30 min
h. 10:00
h. 10:30

TRAY 2
45 min
h. 10:15
h. 11:00

TRAY 3
2:00 h
h. 10:18
h. 12:18

Timer **expired**: remove the tray

Timer **about to expire**: prepare to remove the tray

Timer **in operation**: recipe saved previously setting time core probe temperature

List of all the **MULTI.TIME** menus saved by the user

 For more details, see ► p. 47

List of all the **MULTI.TIME** cooking cycles saved by the user

Set a new **MULTI.TIME** cooking cycle

 For more details, see ► p. 43



38

NEW MULTI.TIME

This section allows the user to create, start and save a new Multi.time recipe.

This is the "base" program, with which the user will use his own single cooking programs.

Example: after creating the MULTI.TIME "Vegetables", the user will load on it his programs for Broccoli, Potatoes, Zucchini etc

Setting and saving the parameters

39 ► **1** To access, touch the "**NEW MULTI.TIME**" icon.

2 The parameters are set in the same way as explained in the "**SET menu**" section.

The cooking cycle does NOT include:

- cooking steps;
- entering a time (cooking is "indefinite").

 For more details, see ► p. 20

You can also choose to use the UNOX INTELLIGENT PERFORMANCE (UIP) technologies by clicking on the relevant symbol, see ► p. 17

3A If you want to **save** the cooking cycle, press the "**SAVE**" button (it is saved in the same way as explained in the "**set menu**" section), otherwise, **3B** press the **START / STOP** button.

4 After pressing the **START / STOP** button, the preheating will start. As for any cooking programs, the user will be notified when the preheating is over.

+ The most frequently used recipes can be tagged as "**FAVORITE**" from the preheating screen (both classical and SMART) see ► p. 15



save the cooking cycle as "**FAVORITE**" see ► p. 15

39

Setting the timers

After the food has been placed in the oven and the door has been closed, set the timers for the different trays. We recommend using timer 1 for the tray at the top of the oven, timer 2 for the tray below and so on. This helps the user to know which tray needs to be taken out when the timer expires (for example, when timer 2 expires, take out the second tray down). **New programs can be added at any time** (e.g. if an order arrives in the kitchen or preparation has been completed).

40 ▶ ① Tap the symbol "+" on the screen.

A screen will open corresponding to the first timer: this can be set by selecting a similar cooking cycle, set to time, using the core probe.

A Setting a timer using a similar cooking cycle (recommended mode)

The oven suggests recipes which have been set with the **"SET" menu** and saved in the **"PROGRAMS" menu**. These have identical temperature and humidity settings in the oven cavity.

② Tap the desired recipe to select it (in the example: "BREAD FINISHING"). The timer expires based on the time set for the selected recipe (in the example: 2 minutes and 13 seconds). Proceed in the same way for each tray placed in the oven (up to a maximum of 10 simultaneous timers). To delete a timer from the list, tap the row of the timer you want to delete and hold for at least 3 seconds.

B Setting a manual timer"

② tap the "clock" icon, on the left.

③ drag the slider or use the buttons **- +** to set the required value;

④ confirm by pressing the **START/STOP** button. Timer expires based on the time set.

C Setting a manual core probe temperature

② tap the "core probe" icon, on the right.

③ drag the slider or use the buttons **- +** to set the required value;

④ confirm by pressing the **START/STOP** button.

Only 1 timer with a core probe can be set. The timer will expire when the set core-probe temperature is reached.

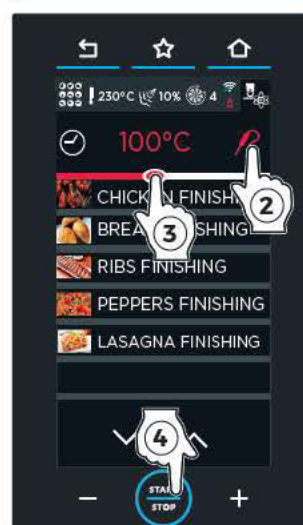
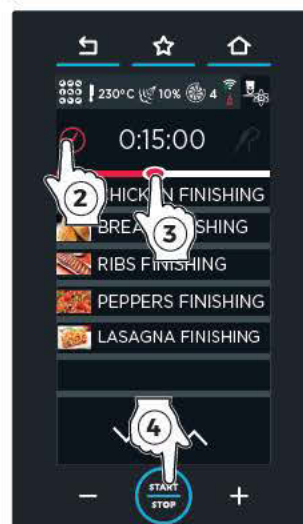
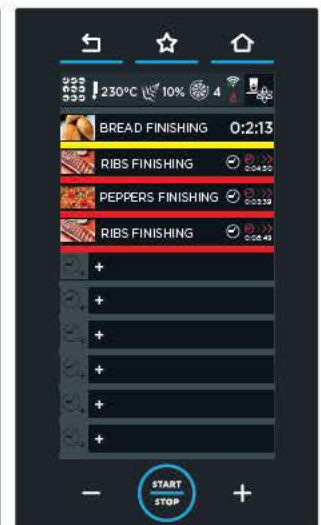
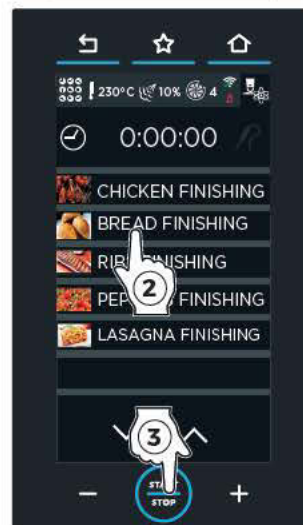
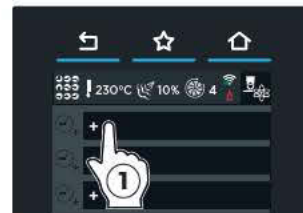

Exiting the function

If you want to exit the function and, therefore, stop the oven operating indefinitely, hold down the **START/STOP** button (approximately 4-5 seconds).

41 ▶ The screen at the side shows a possible cooking cycle scenario in progress.

There are several set timers.

Some are set by:

- by using a recipe which was saved previously (the third)
- entering a time (MANUAL - the second)
- entering a core probe temperature (MANUAL - the fourth)

The colour indicates:

- **green**: timer expired (the food is ready). A beep notifies the user that it is time to take the tray out of the oven. When the door is closed, the timer will disappear from the list.
- **yellow**: the next timer to expire: prepare to take the tray out of the oven.
- **red**: timer in operation (dishes still cooking). The time remaining or the temperature to be reached are indicated on the right.

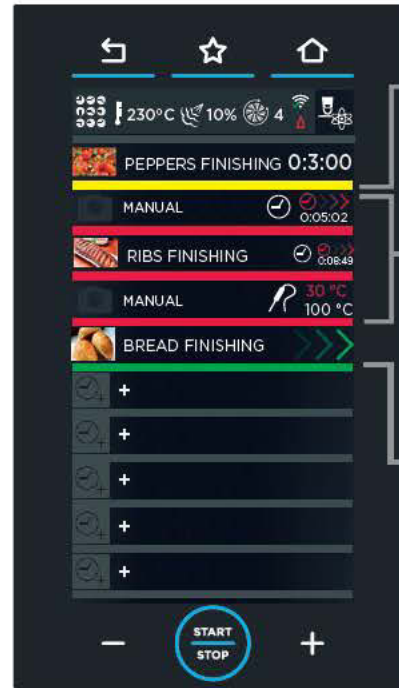

Timer **about to expire**: prepare to remove the tray

Timer **in operation** setting time recipe saved previously core probe temperature

Timer **expired**: remove the tray

41



MULTI.TIME

MY MULTI.TIME

In this section, the user can call up a previously saved cooking cycle by using the **"NEW MULTI.TIME"** menu ▶ p. 43.

This is the most used and recommend method compared to manual set (NEW MULTI.TIME).

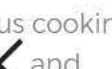
42 ▶ ① To access the list of saved cooking cycles, tap the icon **"MY MULTI.TIME"**: this opens a list of all previously saved cooking cycles.

At the bottom of the screen, the arrows  and  are used to scroll through the various cooking cycles saved in the group, while arrows  and  are used for scrolling through the 16 groups available.

② Tap one of the cooking cycles listed to open the screen that enables you to:

- Ⓐ view/modify the saved cooking cycle;
- Ⓑ duplicate the cooking cycle (to create one with similar parameters);
- Ⓒ delete a saved cooking cycle: in this case the system requests confirmation before permanently deleting the item.
- Ⓓ create a new menu, see ▶ p. 47

③ start the cooking cycle by pressing the **START/STOP** button. After the food has been placed in the oven and the door has been closed, **set the timers** for the different trays see ▶ p. 44

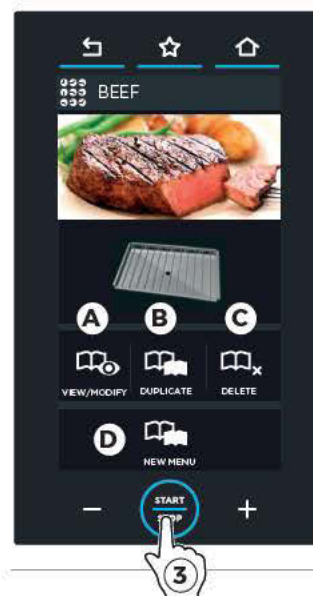
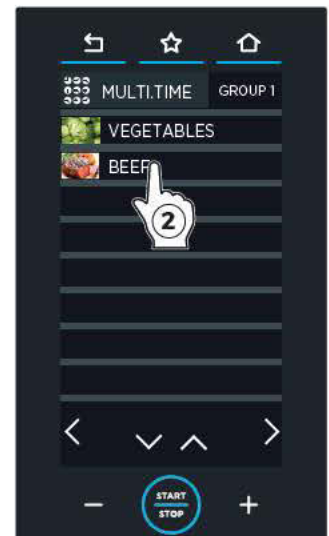

42

45

MY MENU

In this section, the user can call up a previously saved cooking menu by using the **"NEW MENU"** function ▶ p. 47

43 ▶ ① To access the list of saved cooking menu, tap the icon **"MY MENU"**: this opens a list of all previously saved cooking menu.

At the bottom of the screen, the arrows ✓ and ^ are used to scroll through the various cooking cycles saved in the group, while arrows < and > are used for scrolling through the 16 groups available.

② Tap one of the cooking cycles listed to open the screen that enables you to:

- Ⓐ view/modify the saved cooking cycle;
- Ⓑ duplicate the cooking cycle (to create one with similar parameters);
- Ⓒ delete a saved cooking cycle: in this case the system requests confirmation before permanently deleting the item.

③ Start the cooking cycle by pressing the **START/STOP** button. After the food has been placed in the oven and the door has been closed, **set the timers** for the different trays see ▶ p. 44

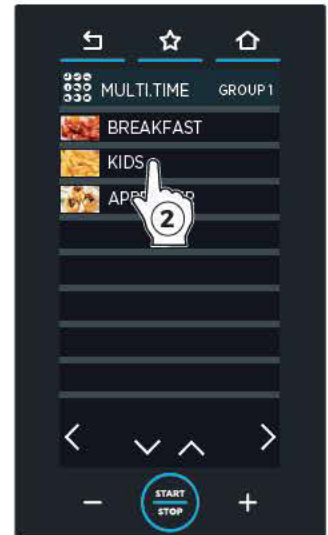
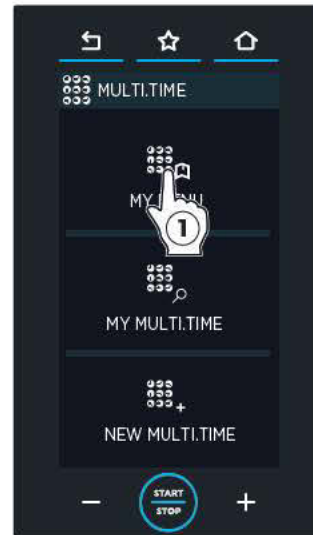

E | Special function NEW MENU function

The **"NEW MENU"** function allows up to 10 timers to be set; these time or temperature values can also be saved.

The trays can be taken out of the oven as the dishes are ready, according to the timers set.

44 ▶ To set the function:

- ① ② call up a recipe saved in the **"MY MULTI.TIME"** menu (in the example, "BEEF");
- ③ tap the **"NEW MENU"** icon;
- ④ ⑤ ⑥ **set the timers** (as explained on page 44) on the basis of the number of trays to be used. The timers are all white showing they are waiting.
- ⑦ When all the required timers have been set, press the **START/STOP** button on the page that shows all of the timers.
- ⑧ If necessary, change **the name** (e.g. "BEEF" becomes "KIDS") **photo** and **tray** (in the same way as explained in the **"set menu"** section).
- ⑨ Press **"SAVE"**.
- ⑩ Select where you want to save the menu.

After, to call up and start a cooking cycle, click on the **"MY MENU"** menu, select the recipe by tapping it and start it using the **START/STOP** button.

For more details, see ▶ p. 46



Use | CHEFUNOX menu

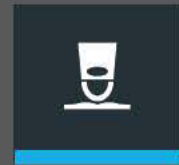

CHEFUNOX MULTI.TIME	48
CHEFUNOX AUTOCOOK	51

FOR "PLUS" MODELS ONLY

This menu displays a series of default recipes set by UNOX.

CHEFUNOX MULTI.TIME

In this section, you can see the **Multi.time programs preset by UNOX**.

You can also choose to use the UNOX INTELLIGENT PERFORMANCE (UIP) technology by clicking on the relevant symbol.

For more details, see ► p. 17

45 ► ① ② Tap the **"CHEFUNOX"** icon and select the section **"CHEFUNOX MULTI.TIME"**;

③ select a Multi.Time program (e.g. "GRILLING");

GRILLING: grilling foods

FAKIRO GRILL: grilling meat, fish and vegetables on the FAKIRO™ Grill trays

FAKIRO PIZZA: baking pizza and focaccia bread

PAN FRYING: cooking breaded vegetables, meats and fish on Pan Fry trays

FRYING: cooking chips/fries

COMBI: convection and steam cooking

BAKING: baking pastry and bread

STEAMING: steam cooking

HOLDING: keeping products warm

④ After select a program, PREHEATING begins.

The screen appears showing:

- the current oven cavity temperature;
- the set preheating temperature;

When the set temperature is reached, a beep notifies you that the preheating step has finished.

⊕ The most frequently used recipes can be tagged as **"FAVORITE"** from the preheating screen (both classical and SMART) see ► p. 15



save the cooking cycle as **"FAVORITE"** see ► p. 15

46 ▶ Once the pre-heating phase has finished, **set the timers** based on the number of trays to be cooked (however, timers can be added at any time, according to the user's needs).

5 Tap the symbol "+" on the screen.

6 The screen relative to the first timer opens: this can be set:

- A selecting a recipe preset by UNOX;
- B selecting one of the compatible user recipes;
- C to time or using a core probe (only 1 timer with a core probe can be set).

A Setting the timer with a preset unox recipe (recommended mode)

The oven proposes PRESET "CHEFUNOX AUTOCOOK" RECIPES.

In this case, the timer is based on the time set for the selected recipe.

The names of the recipes in the screens shown here may differ from those for your oven, as they are examples only.

47 ▶ 1 Tap the icon shown in the figure.

2 Select the type of food to be grilled (e.g. BEEF).

3 Select the desired category (e.g. BEEF STEAK).

4 Based on the selected recipe, the oven offers various screens to customise the cooking cycle:

- temperature
- weight
- thickness
- internal degree of cooking: RARE - MEDIUM - WELL DONE.
- external degree of cooking: LIGHT - MEDIUM - BROWN. The internal and external degree of cooking can also be set by dragging the cursor to the desired temperature.

degree of cooking can also be set by dragging the cursor to the desired temperature.

5 By pressing the **START/STOP** button, the cooking cycle will appear on the Multi.time screen.

Proceed in the same way for each tray placed in the oven (up to a maximum of 10 simultaneous timers).

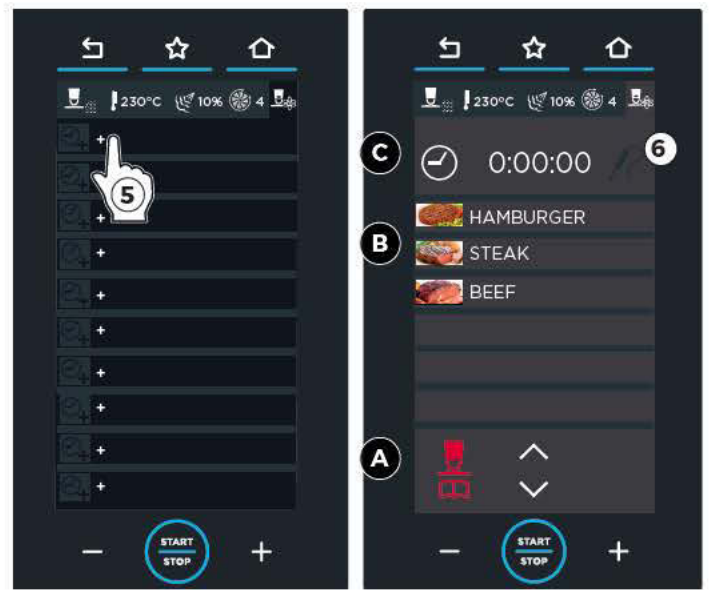

46



47

48 ▶ **B** Setting the timer with a compatible user recipe

The oven proposes USER RECIPES, saved previously with parameters compatible with the type of program selected (e.g. hamburger). In this case, the timer is based on the time set for the selected recipe.

48 ▶ **C** Setting a manual timer or core probe temperature

- ② tap the "clock" or "core probe" icon;
- ③ drag the slider or use the buttons **-** **+** to set the required value;
- ④ confirm by pressing the **START/STOP** button.

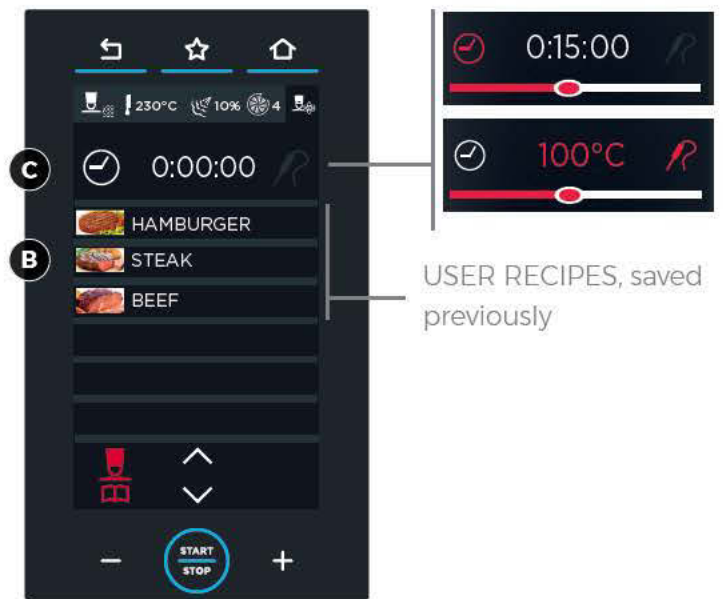

USER RECIPES, saved previously

49 ▶ The screen at the side shows a possible cooking cycle scenario in progress.

There are several set timers.

Some are set by:

- by using a recipe which was saved previously (the third)
- entering a time (MANUAL - the second)
- entering a core probe temperature (MANUAL - the first)

The colour indicates:

- **green**: timer expired (the food is ready). A beep notifies the user that it is time to take the tray out of the oven. When the door is closed, the timer will disappear from the list.
- **Yellow**: the next timer to expire: prepare to take the tray out of the oven.
- **red**: timer in operation (dishes still cooking). The time remaining or the temperature to be reached are indicated on the right.

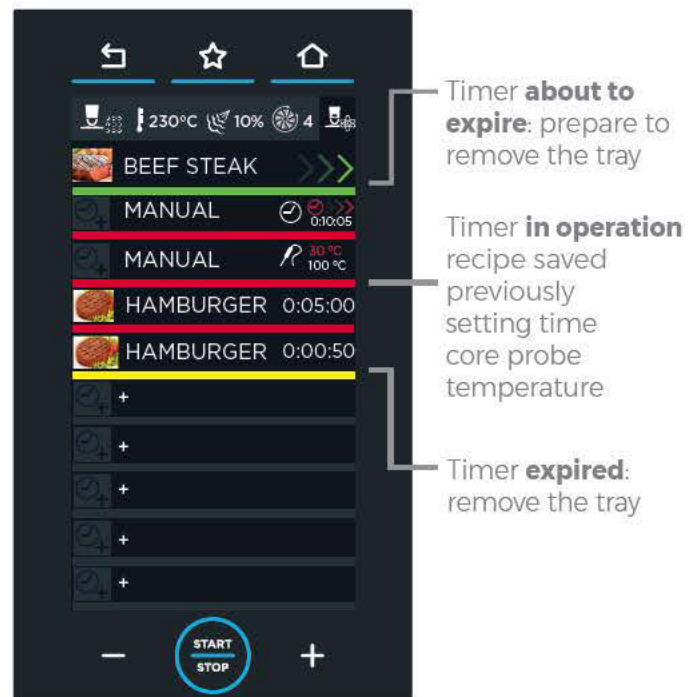

Timer **about to expire**: prepare to remove the tray

Timer **in operation** recipe saved previously setting time core probe temperature

Timer **expired**: remove the tray

CHEFUNOX AUTOCOOK

In this section, you can see the “**CHEFUNOX auto-cook**” programs preset by UNOX.

The names of the recipes in the screens shown here may differ from those for your oven, as they are examples only.

50 ▶ **1** **2** Tap the icon “**CHEFUNOX**” and select the section “**CHEFUNOX AUTOCOOK**”;
3 select a program (for example “**GRILLING**”):

GRILLING: grilling foods

PAN FRYING & FRYING: steaming vegetables, pan-frying meat and fish and breaded products on Pan Fry trays

ROASTING: cooking roasts

BRAISING: cooking braised meat

OVERNIGHT: overnight cooking

STEAMING: steam cooking

COMBI: convection and steam cooking

BREAKFAST & SNACKS

BAKING: baking pastry and bread

SOUS VIDE: vacuum cooking

REGEN: regenerating frozen foods

4 Select the type of food to be grilled (e.g. BEEF).

5 Select the desired category (e.g. BEEF STEAK).

6 Based on the selected recipe, the oven offers various screens to customise the cooking cycle:

- weight
- thickness
- internal degree of cooking: RARE - MEDIUM - WELL DONE.
- external degree of cooking: LIGHT - MEDIUM - BROWN. The internal and external degree of cooking can also be set by dragging the cursor to the desired temperature.

7 When pressing the “**START STOP**” button: PREHEATING starts and a screen appears indicating:

- the current oven cavity temperature;
- the preheating advancement.

when preheating is over, a beep signals the end of the preheating STEP and an icon appears to indicate that the food should be put in the oven. After this operation, the cooking steps that have been appropriately modified according to the weight, thickness, and internal/external cooking settings of the product will automatically start after the oven door has been closed.

To add more recipes and select a regional menu, see ▶ p. 74

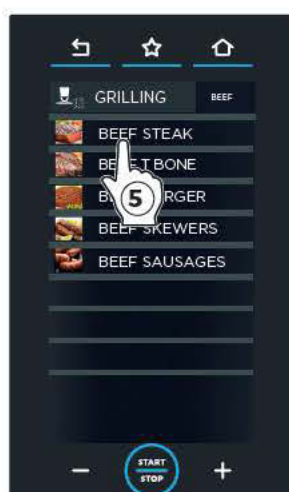
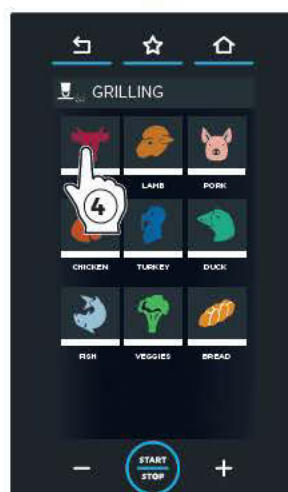

Use | MISE EN PLACE menu



NEW MISE EN PLACE	53
MY MISE EN PLACE	55
MY MENU	56

FOR "PLUS" MODELS ONLY

The "Mise en Place" menu allows you to have up to 10 different dishes ready at the same time. Your CHEFTOP™ or BAKERTOP™ will instruct you when to insert the different trays. A maximum of 10 timers can be set (corresponding to a maximum of 10 different foods being cooked at the same time).

51 ▶ In the example shown here, 3 trays containing different foods need to be ready all at the same time, for example, at **12:00**.

For each tray, a timer will be set with a different end time, as each food requires a different amount of cooking time | 1:30 mins, 50 mins, 60 mins and 1:40 mins.

Depending on the preparation time and the time I want the food to be ready, **the oven will indicate when each tray needs to be placed** in the oven via a beep

- ➔ at 10:00 put the TRAY 4 in (2:00 mins)
- ➔ at 10:30 put the TRAY 1 in (1:30 mins)
- ➔ at 11:00 put the TRAY 3 in (60 mins)
- ➔ at 11:10 put the TRAY 2 in (50 mins)

so that they can all be taken out of the oven at the same time, for example, at **12:00**.

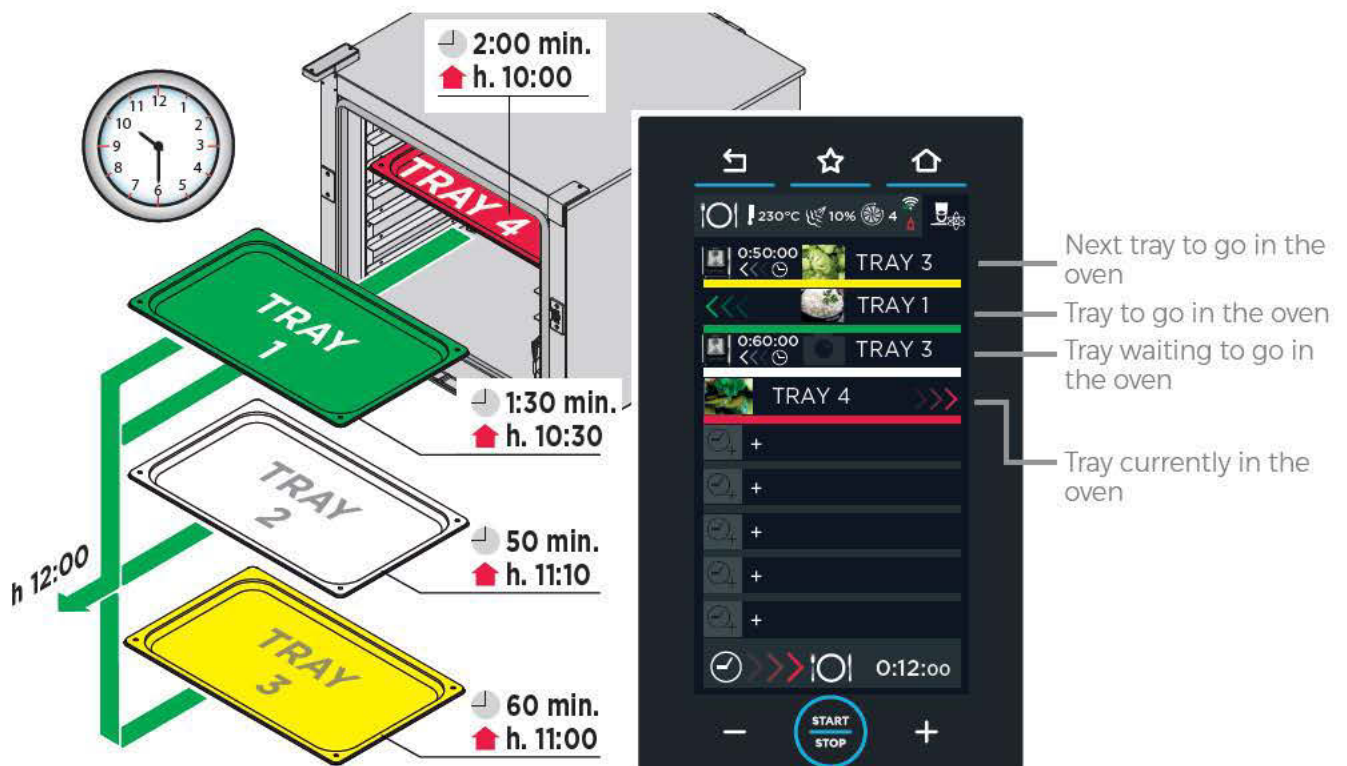

List of all **Mise en place** menus saved by the user

List of **Mise en place cooking cycles** saved by the user

Set a new **Mise en place cooking cycles**

For more details, see ► p. 53



NEW MISE EN PLACE

Here you can create, start and save a new "Mise en place" recipe.

Setting and saving the parameters

53 ► ① To access, touch the "**NEW MISE EN PLACE**" icon.

② The parameters are set in the same way as explained in the "**SET menu**" section.

The cooking cycle does NOT include:

- cooking steps;
- entering a time (cooking is "indefinite").

For more details, see ► p. 20

You can also choose to use the UNOX INTELLIGENT PERFORMANCE (UIP) technology by clicking on the relevant symbol, see ► p. 17

③A If you want to **save** the cooking cycle, press the "**SAVE**" button (it is saved in the same way as explained in the "**set menu**" section), otherwise, ③B press the **START / STOP** button.

④ After pressing the **START / STOP** button, the preheating will start. As for any cooking programs, the user will be notified when the preheating is over.



Setting the timers

Set the timers for the first try inserted.

54 ▶ ① Tap the symbol "+" on the screen.

A screen will open corresponding to the first timer: this can be set by selecting a similar cooking cycle, set to time, using the core probe.

A Setting a timer using a similar cooking cycle (recommended mode)

The oven suggests recipes which have been set with the "SET" menu and saved in the "PROGRAMS" menu. These have identical temperature and humidity settings in the oven cavity (in the example: "VEGETABLES").

② Tap the desired recipe to select it. The timer expires based on the time set for the selected recipe (in the example: 20 minutes). Proceed in the same way for each tray placed in the oven (up to a maximum of 10 simultaneous timers).

To delete a timer from the list, tap the row of the timer you want to delete and hold for at least 3 seconds.

B Setting a manual timer"

② tap the "clock" icon, on the left.

③ drag the slider or use the buttons **-** **+** to set the required value;

④ confirm by pressing the **START/STOP** button. Timer expires based on the time set (in the example: 15 minutes).

C Setting a manual core probe temperature

② tap the "core probe" icon, on the right.

③ drag the slider or use the buttons **-** **+** to set the required value;

④ confirm by pressing the **START/STOP** button. Only 1 timer with a core probe can be set. The timer will expire when the set core-probe temperature is reached.

Exiting the function

If you want to exit the function and, therefore, stop the oven operating indefinitely, hold down the **START/STOP** button (approximately 4-5 seconds).

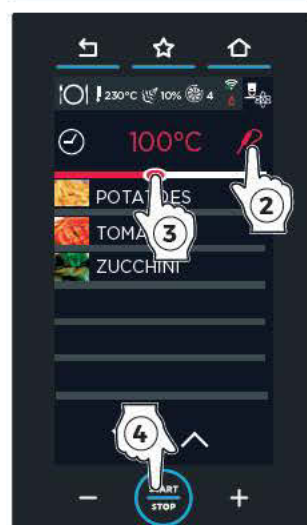
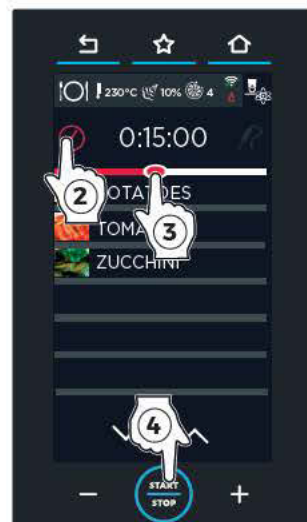
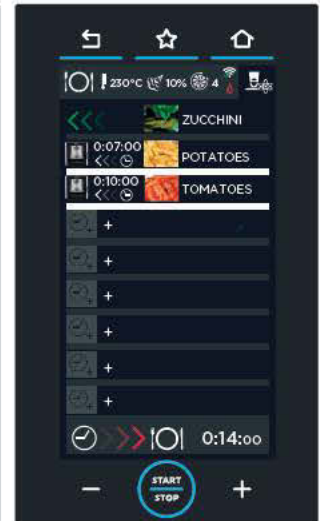
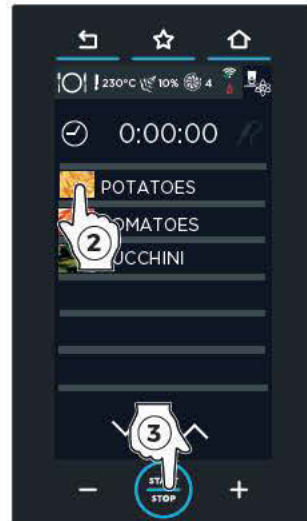

55 ▶ The screen at the side shows a possible cooking cycle scenario.

The first tray to be placed in the oven (green timer) will always be the one which requires the longest cooking time or the one which requires the core probe (the time required for it to reach the set temperature cannot be predicted); after this, put the trays in the oven based on the cooking time required for each tray.

⚠ The colour indicates:

- **green:** put the tray in the oven >>>. When the door is closed, the timer turns red indicating that food is being cooked on the tray. A beep indicates when a new tray needs to be put in the oven. If you put the tray in the oven within **45 seconds** of the beep, it can be taken out of the oven at the set time otherwise, it will need to be taken out of the oven later.
- **yellow:** next tray to go in the oven
- **red:** tray currently in the oven
- **white:** tray waiting to go in the oven.

Programs can be added but ONLY if they are not longer (as duration) than the longest left in the list (in the example, programs longer than 14 minutes could NOT be added)



MY MISE EN PLACE

In this section, the user can call up a previously saved cooking cycle by using the “**NEW MISE EN PLACE**” menu ▶ p. 53.

This is the most used and recommend method compared to manual set (NEW MISE EN PLACE).

56 ▶ ① To access the list of saved cooking cycles, tap the icon “**MY MISE EN PLACE**””: this opens a list of all previously saved cooking cycles.

At the bottom of the screen, the arrows ✓ and ^ are used to scroll through the various cooking cycles saved in the group, while arrows < and > are used for scrolling through the 16 groups available.

② Tap one of the cooking cycles listed to open the screen that enables you to:

- Ⓐ view/modify the saved cooking cycle;
- Ⓑ duplicate the cooking cycle (to create one with similar parameters);
- Ⓒ delete a saved cooking cycle: in this case the system requests confirmation before permanently deleting the item;
- Ⓔ create a today's menu, see ▶ p. 56
- Ⓕ create a new menu, see ▶ p. 57.

③ start the cooking cycle by pressing the **START/STOP** button. After the food has been placed in the oven and the door has been closed, **set the timers** for the different trays see ▶ p. 54

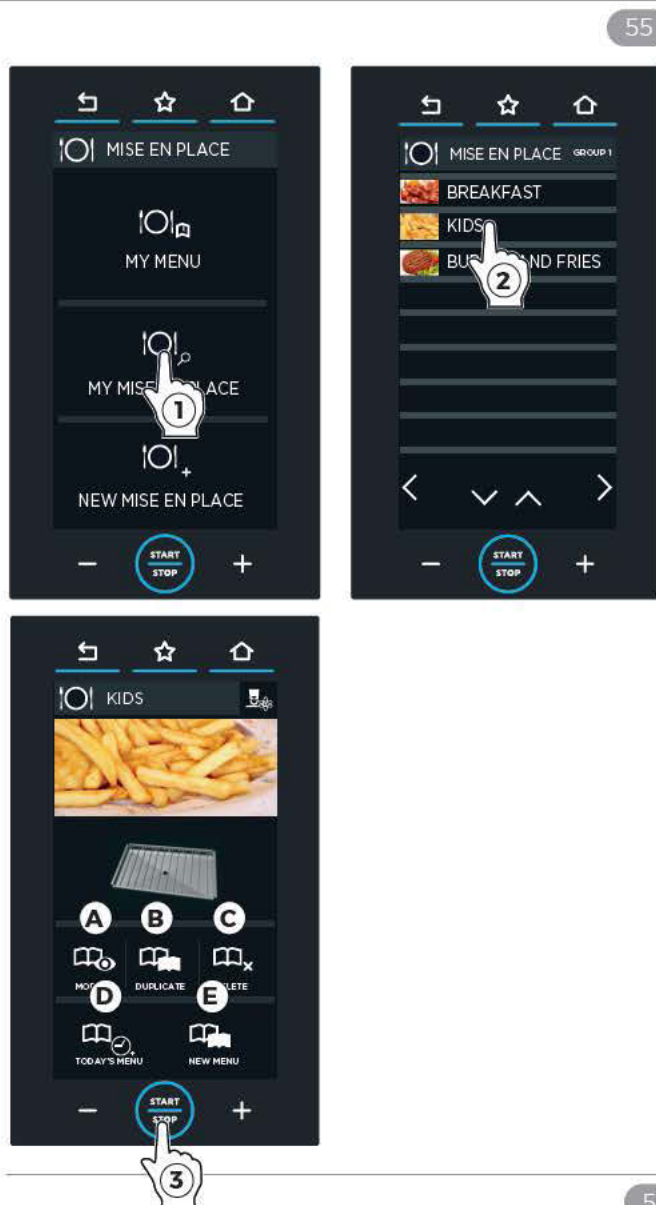

MY MENU

In this section you can recall a previously saved cooking cycle using the **"NEW MENU"** function ▶ p. 57.

57 ▶ ① To access the list of saved cooking menu, tap the **"MY MENU"** icon: this opens a list of all previously saved cooking menu.

At the bottom of the screen, the arrows ▼ and ▲ are used to scroll through the various cooking cycles saved in the group, while arrows ◀ and ▶ are used for scrolling through the 16 groups available.

② Tap one of the cooking cycles listed to open the screen that enables you to:

- Ⓐ view/modify the saved cooking cycle;
- Ⓑ duplicate the cooking cycle (to create one with similar parameters);
- Ⓒ delete a saved cooking cycle: in this case the system requests confirmation before permanently deleting the item.

③ start the cooking cycle by pressing the **START/STOP** button. After the food has been placed in the oven and the door has been closed, **set the timers** for the different trays see ▶ p. 54

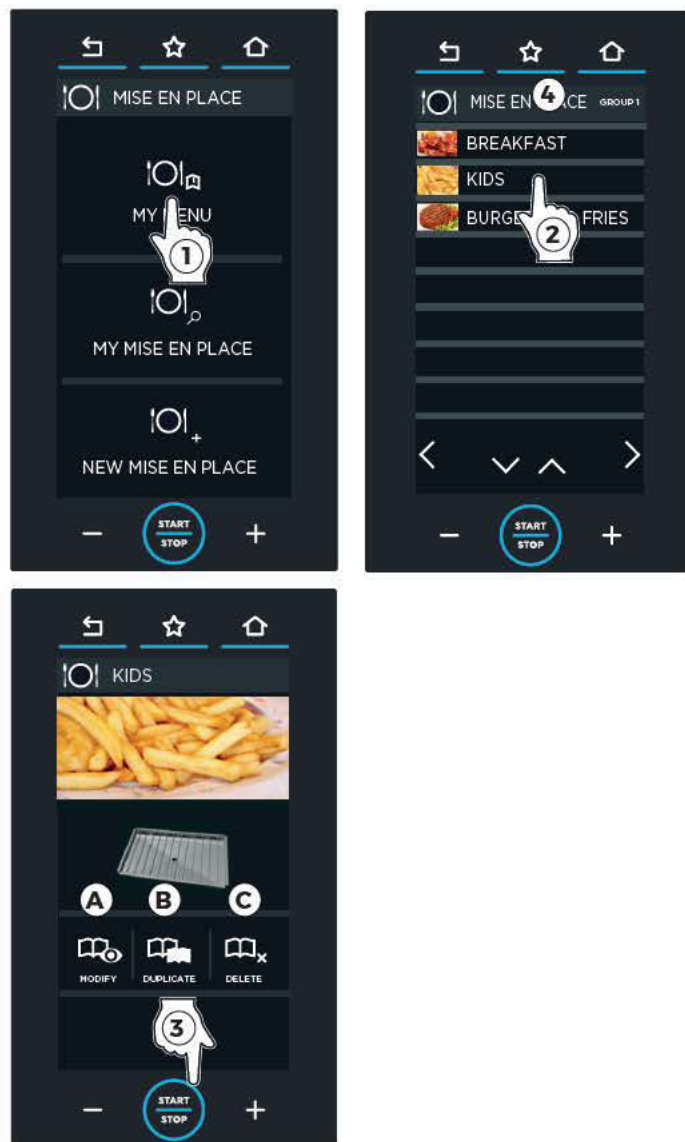

57

F | Special function TODAY'S MENU function

The **TODAY'S MENU** function allows you to set up to 10 timers.

To set the function:

- ① recall a recipe saved in the **"MY MISE EN PLACE"** menu (in the example: "SMALL CHICKEN");
- ② tap the **"TODAY'S MENU"** icon;
- ③ set the timers as explained on ▶ p. 54 based on the number of trays which are to be used. The timers are all white showing they are waiting.
- ④ When all the required timers have been set, press the **START/STOP** button on the page that shows all of the timers.



G | Special function **NEW MENU** function

The **"NEW MENU"** function enables you to set up to 10 timers without needing to place trays in the oven or start a cooking cycle.

58 ▶ To set the function:

- 1 2 call up a recipe saved in the **"MY MISE EN PLACE"** menu (in the example, "BEEF");
- 3 tap the **"NEW MENU"** icon;
- 4 set the timers (as explained on page 54 on the basis of the number of trays to be used. The timers are all white showing they are waiting.
- 5 When all the required timers have been set, press the **START/STOP** button on the page that shows all of the timers.
- 6 If necessary, change the name (e.g. "BEEF" becomes "KIDS") **photo** and **tray** (in the same way as explained in the **"set menu"** section).
- 7 Press **"SAVE"**.
- 8 Select where you want to save the menu.

After, to call up and start a cooking cycle, click on the **"MY MENU"** menu, select the recipe by tapping it and start it using the **START/STOP** button.



Use | ROTOR.KLEAN menu











Warnings regarding washing cycles	58
How to use washing programs (ROTOR.KLEAN)	59
Scheduling washes	60
Refilling detergent tank	61

This menu is used to access to the washing list.

WARNINGS REGARDING WASHING CYCLES

The ovens come equipped with one/two rotor(s) for cleaning the oven cavity.

-  Before starting a cleaning cycle, **make sure that there are NO trays** in the oven chamber, otherwise the washing is ineffective.
-  **Carefully read the product safety data sheet before handling and using the detergent.**
-  **Do not open the oven door during washing as this could cause injury to eyes, mucous membranes and skin caused by contact with the cleaning chemicals used. these chemicals are sprayed by the rotor within the cooking chamber and moved by strong air currents.**
-  **Do not tamper with the tank and its connections to the oven for any reason as this could cause a risk of injury or death.**
-  **The detergent must not come into contact with the skin, eyes or mucous membranes. in case of contact with the detergent, follow the instructions on the safety data sheet.**
-  **Never touch the detergent with bare hands.**
-  For ovens with a trolley, run the washing cycle with the trolley inside the oven cavity, without any trays, and lock the trolley using the front wheel brakes.
-  Periodically check the presence of rust stains inside the oven chamber: if they are found, contact a Service Centre urgently because the water is probably damaging the oven; prompt action will extend the lifespan of the equipment.



When the end is closed with the plug DO NOT use the wash cycle or wash the chamber with large amounts of water as this could cause flooding.

HOW TO USE WASHING PROGRAMS (ROTOR.KLEAN)

In this section, start one of the following washing or rinse programs:

RINSE	00:17	cold rinse
QUICK	01:02	oven cavity only slightly dirty
SHORT	01:09	cooking cavity slightly dirty
MEDIUM	01:27	cooking cavity averagely dirty
LONG	02:32	oven cavity very dirty
SOFTENING	00:12	pre-washing cycle to soften particularly tough dirt spots. Use it before a regular washing

The automatic SENSE.Klean technology checks the level of dirt in the oven and displays the result on a coloured bar:

- **blue:** oven only slightly dirty (0-60%)
- **yellow:** oven averagely dirty (60-90%)
- **red:** oven very dirty (over 90%)

using this value, it suggests the most suitable wash, highlighting it with a symbol  (in the example: SHORT - a quick wash).



Warning: DO NOT open the door during washing. **RISK OF INJURY TO EYES, MUCOUS MEMBRANES AND SKIN CAUSED BY CONTACT WITH THE CLEANING CHEMICALS USED.**

- 59 ▶ ① Tap the Rotor.Klean icon
 ② Tap the name of the program you want to start.
 ③ Tap the **START/STOP** button to start the washing cycle.

60 ▶ The display shows the time remaining until the end of the washing cycle.

The colour of the clock indicates:

- **red:** washing program in progress.
- **Yellow:** less than 1 minute until the selected washing program finishes
- **green:** the wash has finished, it automatically returns to the **"HOME"** page.

To **stop** a wash cycle in progress in advance, press the **START/STOP** button: a quick rinse cycle will automatically start and run for approximately **12 minutes** to remove any trace of residual detergent from the oven cavity.



-  Washing complete
 -  Washing in progress (less than 1 min. remaining)
 -  Washing in progress (more than 1 min. remaining)
- Residual time** until the end of the program in progress

SCHEDULING WASHES

61 This menu is used **to automate washes**, meaning you can be sure to find your oven perfectly clean every day, without worrying about manually launching wash cycles.

The following can be set from this screen using the **-** **+** buttons:

- **A** the washing cycle **start time** (START WASHING AT);
- **B** the time you want **the oven to be ready** at (OVEN READY AT) after being washed, rinsed and dried, depending on the chosen program;
- **C** whether the washing cycle only needs to be **run once**, on the day the programming is set (ONLY ONCE) or **every day** (EVERY DAY).

+ What happens if I set both the start wash time (e.g. 6:00) and the oven ready time (11:00) and I choose a **SHORT** wash (lasting 41 mins)?

Once the wash has finished at 6:41, the oven maintains a temperature of approximately 200°C until 11:00.

What happens if I set the start wash time to 7:00 and the oven ready time to 6:00?

The oven maintains a temperature of 200°C from 7:41 (the time the wash cycle finishes) until 6:00 the next day.

What happens if I only set the oven ready time and not the wash start time?

The oven automatically calculates the start time according to the duration of the wash cycle you have chosen. For example, with a **SHORT** wash cycle (duration: 41 mins) and the oven ready time set to 11:00, the wash cycle will start at 10:19.

ONLY ONCE:
the programming runs today only

EVERY DAY:
the programming runs every day

VIEW ACTIVE SCHEDULING:
this is used to view the current program schedule

CLEAR SCHEDULING: cancel all current scheduling

REFILLING DETERGENT TANK

⚠ Only fill with the 1-litre bottles of the **UNOX. Det&Rinse Plus** detergent.

62 ▶ To refill the detergent:

- **Wear gloves to prevent your hands from coming into direct contact with the detergent.**
- Pull out the tank from under the oven until you hear a "click".
- Open the lid of the tank.
- Open the cap of the UNOX 1-litre detergent bottle without removing/piercing the protective film.
- Turn the bottle upside down and screw it on the tank (by screwing the bottle, a pin in the tank breaks the protective film, which allows the detergent to come out).
- Once the bottle is empty, unscrew it to remove it. Avoid dripping.

⚠ **The detergent must not come into contact with the skin, eyes or mucous membranes. In case of contact with the detergent, follow the instructions on the safety data sheet.**

- Repeat the process up to the maximum level allowed, indicated on the front of the tank. (Maximum capacity of the 4 litre tank = 4 bottles).
- Remove the bottle.
- Reposition the tank under the oven until it stops.
- Dispose of the gloves, taking care not to touch the areas covered with the detergent.

⚠ **Never touch the detergent with bare hands.**

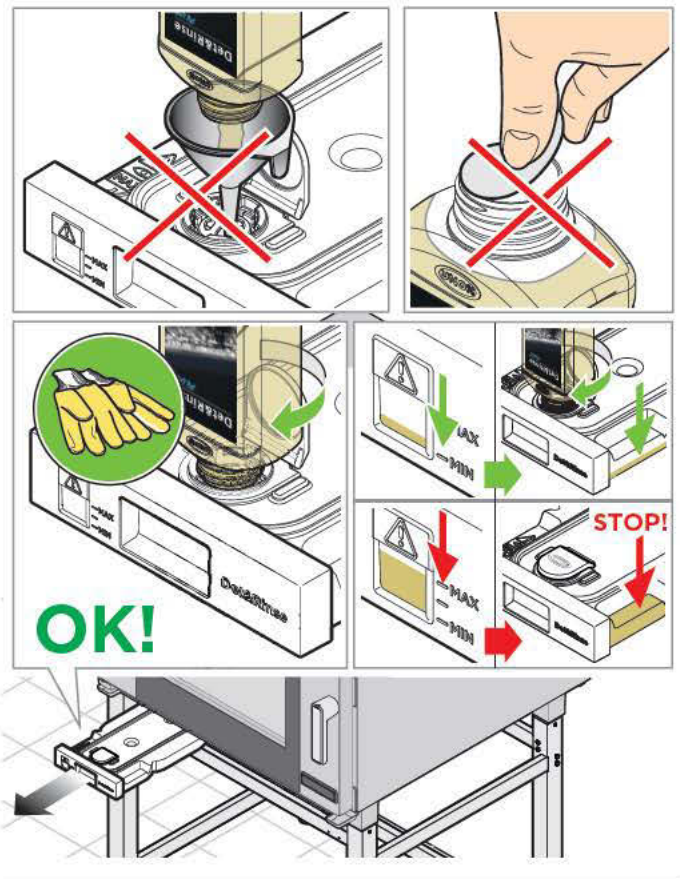

62

Use | READY.COOK menu READY.BAKE menu



This is used to access some preset programs, to start certain cooking methods quickly.

63 ▶ To access the preset programs:

- ① tap the **"READY.COOK | READY.BAKE"** icon;
- ② select the **desired program** (temperature and STEAM.Maxi e DRY.Maxi cannot be changed by the user);
- ③ tap the **START/STOP** button: a preheating phase will start;
- ④ after pre-heating, to determine the end of the cooking set up to 4 timers (cooking duration) or use the core probe method (core temperature).

You can also choose to use the UNOX INTELLIGENT PERFORMANCE (UIP) technology by clicking on the relevant symbol.

📖 For more details, see ▶ p. 17



64 ► The screen side shows a possible cooking cycle in progress. There are four set timers: three are set by entering a time (for example, the first, second and fourth), and one is set by inserting the core probe temperature (e.g. the third, 70°C). The colours indicate:

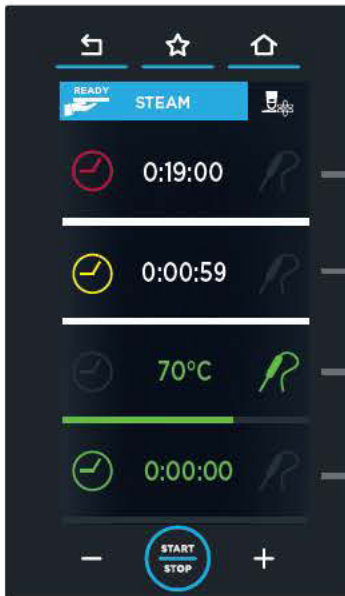

red: timer in operation (dishes still cooking).

yellow: timer about to expire (the food is almost ready). Prepare to take the tray out of the oven

green: temperature reached. A beep notifies the user that it is time to take the tray out of the oven. When the door is closed, the timer will disappear from the list

green: timer expired. A beep notifies the user that it is time to take the tray out of the oven. When the door is closed, the timer will disappear from the list

Stats DDC menu



Set goals	65
HACCP data	65
Consumption	66

DATA DRIVEN COOKING menu allows you to control HACCP data and your oven at any time, anywhere. You can monitor its operating conditions in real-time, create recipes and send them to your ovens. The AI transforms the consumption data into useful information in order to increase your daily profit.

DDC.Stats gives you full control over energy, water and detergent consumption and also over cooking times and oven usage. Compare the performance of the ovens in your network, detect anomalies and get useful information to improve your business performances.

65 ▶ The screen provides access to 3 areas:

- GOAL:** you must set the daily number of oven operating hours, which is required to optimise costs. A histogram is then shown to indicate whether you achieved the goal. This helps you to understand whether you are using the oven in the best way possible.
- HACCP DATA:** HACCP data can be used to monitor the processing of foods for which there a risk of biological, chemical or physical contamination. More specifically, every 30 seconds the following readings are taken:
 - oven cavity temperature;
 - temperature measured by the core probe;
 - vacuum-seal (sous vide) probe temperature.
- CONSUMPTION:** tap the “consumption” icon to call up a screen showing the dates the oven was used.

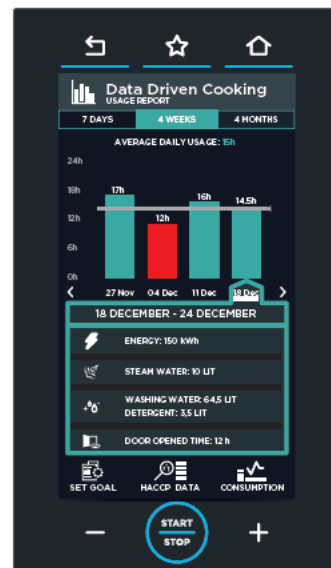
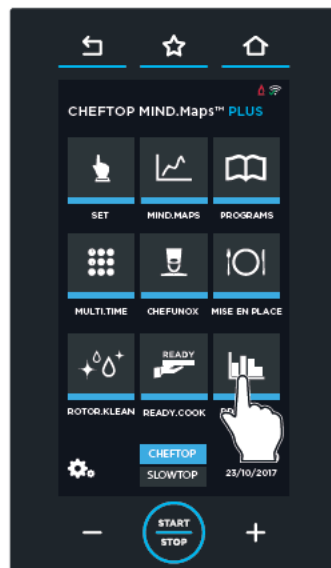

SET GOALS

- 66 ▶ ① Select **"SET GOAL"**.
- ② Drag the blue bar or use the **- +** buttons to set the number of hours the oven should be used for per day, in order to optimise costs (e.g. 14 hours).
- ③ Press **"SAVE"**.
- ④ Choose whether to display the goals for Days, Weeks or Months ▶ a histogram will appear showing:
- the **blue bars** indicating when a goal has been reached i.e. the oven has been in operation for more than 14 hours.
 - the **red bars** indicating when a goal has NOT been reached i.e. the oven has NOT been in operation for more than 14 hours.



66

HACCP DATA

- 67 ▶ ① Select **"HACCP DATA"**.
- ② Select the oven operating date for which you want to see the HACCP data.
- ③ The relative data are displayed during operation.



67

CONSUMPTION

68 ► When touching the **"consumption"** icon, a screen appears that shows the dates on which the oven was used.

① Select **"CONSUMPTION"**.

② select the **date** for which you want to view the consumption data:

③ select the **program**, the following consumption is shown

- electricity/gas consumed;
- litres of water consumed to make the steam in the oven cavity;
- litres of water and detergent consumed for the washing cycles.



Settings menu



Language	69
Date and time	69
Unit of measurement	69
Network	70
Consumable prices	70
USB	71
Unox.Care	72
Options	73
UNOX Service	75
Device info	75

69 ▶ The USER MENU enables the user to set the oven parameters.

The SERVICE MENU is for specialist operators only, whereas the "USER SETTINGS" can be accessed by any operator by entering the password "4456" and confirming with "OK".

The NETWORK MENU enables or disables oven control via remote network access and allows you to configure the relevant parameters

▶ For more details, see p. 70



LANGUAGE

70 ► Here you can select the language, which will be used for all menu entries. You can scroll through the list of available languages using the arrows ▼ and ▲.

Simply tap a language to select it.

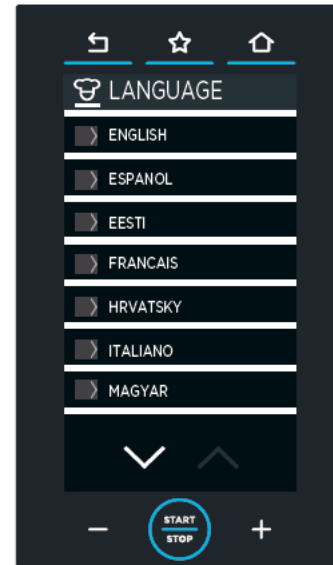

70

DATE AND TIME

71 ► This lets you modify the date and time settings of the menu. It is necessary to:

- set the **Time zone**, clicking on the relevant geographic area and selecting the country, scrolling through the list using the arrows ▼ and ▲;
- enter the current standard clock time as **winter time** (also called standard time) or **summer time** (also called daylight saving time); alternatively, the "AUTOMATIC" setting allows the time to be updated automatically;
- set the current **time, year, month** and **day**.



71

UNIT OF MEASUREMENT

72 ► Select the unit of measurement for the:

- **temperature** (°C/°F);
- **volume** (litres or gallons);
- **thickness** (mm or inches);
- **weight** (kg or pounds);
- **energy** (kWh or BTU).

It also allows you to set the **current currency** (€, \$, etc.), and, by entering this menu, you can also set:

- whether the currency symbol should come before or after the value (symbol position);
- whether to use a decimal point "." or comma "," in decimal numbers (decimal sign).



72

NETWORK

73 ▶ This menu enables or disables oven control via remote network access and allows you to configure the relevant parameters.

Connection test

Connection test for all two types of connection

WI FI name: tap here to select the network to connect to (or to type it manually)

WI FI password: tap here to enter the WiFi password

Cloud PIN

The PIN code needed to connect the oven with DDC.unox.com and the app. Each oven has its own pre-set PIN code. The PIN code can be modified to connect to a personal DDC account; in this case, the oven must be paired.

DHCP

This allows you to obtain the network settings from the DHCP server (for Wi-Fi connections, always leave the DHCP set to "ON").

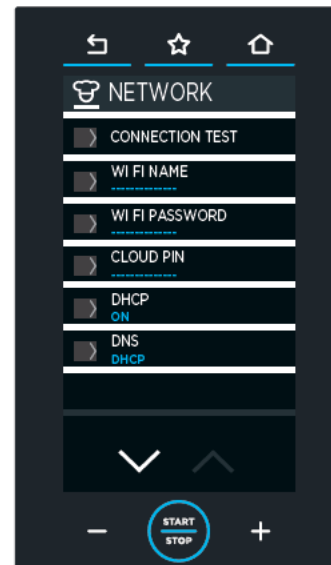

73

CONSUMABLE PRICES

74 ▶

It allows you to enter the cost of **electricity, gas** (only for gas models), **water** and **detergent** (the currency is set in the "Unit of measurement" section on this screen)



74

USB

75 ▶ This section allows you to import or export materials from your own USB stick (FT32 formatted and with capacity between 4 and 16 GB).

The USB port is located below the LCD panel and allows you to import or export materials from your own USB stick (FT32 formatted and with capacity between 4 and 16 GB).

- EXPORT PROGRAMS ▶ exports recipes from the oven to a USB stick;
- IMPORT PROGRAMS ▶ imports recipes from the USB stick to the oven;
- IMPORT PICTURES ▶ imports pictures from the USB stick to the oven, e.g. an image of one of your particularly successful dishes. To be used, the images must be converted: see ▶ 76

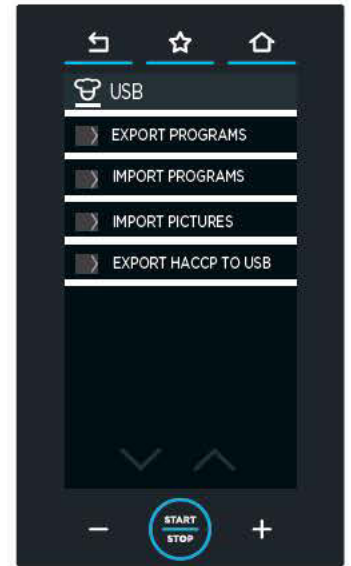

75

① Download the UNOXDIR.zip folder from the software section of UNOX Infonet

② Save the UNOXDIR.zip folder onto your USB stick

③ Unzip the UNOXDIR.zip folder that you have just downloaded

④ Open the UNOXDIR folder

⑤ There are two folders inside this folder (ZDATA and IMAGES) as well as an .exe file (IMAGECONVERTER.EXE)

⑥ Copy the images you want to use in the IMAGE folder

⑦ Start the IMAGECONVERTER.EXE program. You can now use the images!

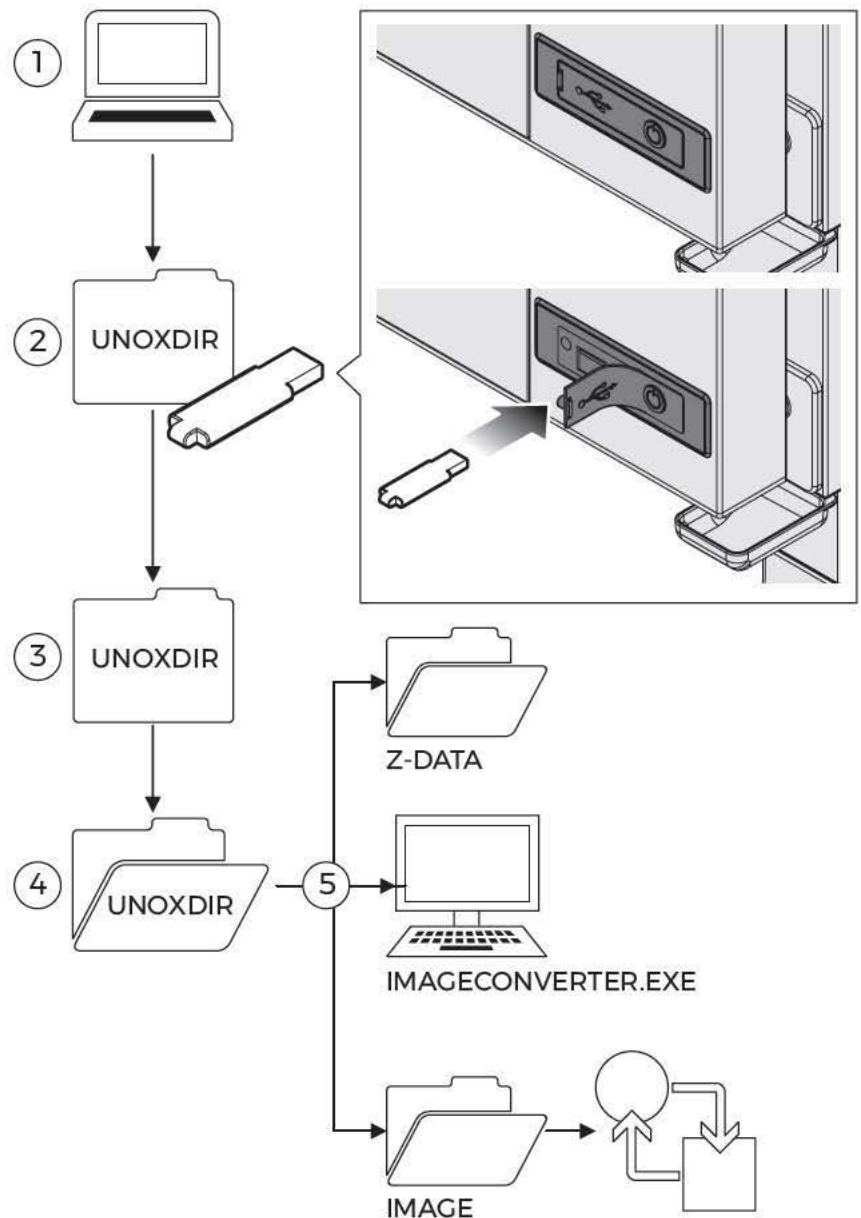

76

UNOX.CARE

77

UNOX.Pure | UNOX.Finest | BAKERY.Pure

① Remaining volume

Thanks to an internal litre counter (which has to be reset each time the filter is changed), the user can find out at any given moment how many litres of incoming water remain until the filter will next need changing (in the example: 7,083 litres remaining before the filter needs replacing)

② Temporary Water hardness

The hardness of the water can be set on this screen within a range of 3 °dH to 10 °dH (German degrees). Can be measured with the orange test kit

③ Activate counter

After having replaced the filter, the litre counter must be reset so that it starts counting from zero again. To carry out this operation, enter the PIN code identified on the kit box.

UNOX.PURE-RO

① Remaining volume

Thanks to an internal litre counter (which has to be reset each time the filter is changed), you can view how many litres of incoming water are left at any given moment until the filter will next need changing (in the example: 7,083 litres remaining before the filter needs replacing).

② Total Water hardness

The hardness of the water can be set on this screen within a range of 3 °dH to 10 °dH (German degrees). Can be measured with the green test kit

③ Activate counter

In order for the OSMOSI system to work properly, this parameter must be set to "ON" (default is "OFF"). If, for any reason, the reverse osmosis system is removed from the oven, or while waiting for a repair, set it back to "OFF".

④ Reset counter

After having replaced the filter, the litre counter must be reset so that it starts counting from zero again. To do this, you need to access the screen and confirm (DELETE).

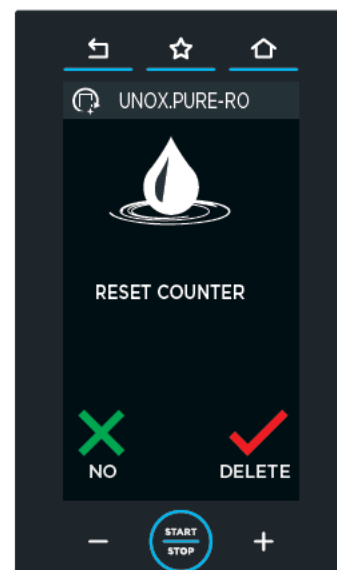
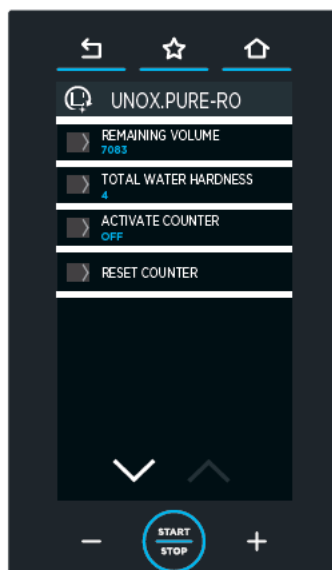
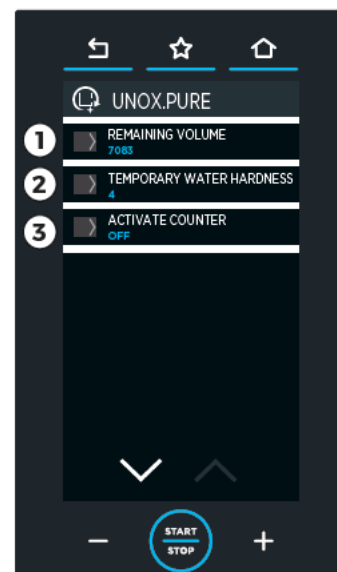

77

OPTIONS

78 ▶

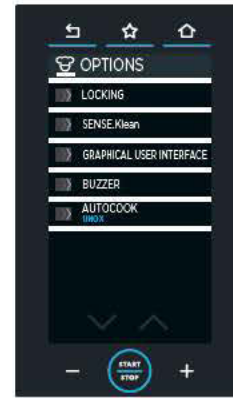

78

79 ▶ LOCKING

Lock program view

This allows you to start the cooking programs stored by users but prevents them from being displayed, edited and deleted.

Lock user programs

This allows you to start and display the cooking programs stored by users but prevents them from being edited and deleted.

Lock manual cookings

Blocks the possibility of manual cooking (SET menu).



79

80 ▶ SENSE.Klean

Most used programs

Set the type of cookings you do more frequently: it will help SENSE.Klean to be more precise

Reset dirtyness level

Returns the SENSE.Klean counter to zero

81 ▶ GRAPHICAL USER INTERFACE

Consumption data in currency

When active (ON), it converts consumption data (e.g. litres used for steam) into costs, based on the currency set.

Seconds to show slides in cooking

Sets the number of seconds after which, with no interaction with the display, the screen with the cooking cycle in progress is displayed.

Lock screen timeout

If the oven door is opened, the screen to the side indicates that it is not possible to use the display for safety reasons. When the door is closed or after pressing and holding the "HOME" button, the screen can be used again. If the set value is:

- = "0" ▶ no screen appears even if the door is open;
- ≠ "0" ▶ the set value indicates the number of seconds after which the display unlocks once the door is closed. For example, if the value is set to "5", the panel will unlock 5 seconds after the door has been closed.



80



81

Home page icons

From this submenu, you can show, hide or deactivate the icons of the main menu (SET, PROGRAMS, etc.):

Settings:

- **SHOW** ▶ normal display of the selected icon
- **HIDE** ▶ hides the selected icon
- **SKIP** ▶ if some icons are skipped, the remaining icons rearrange themselves to fill the empty spaces
- **LOCK** ▶ lock the menu but leave it visible
- **DEACTIVATE** ▶ lock the menu and make it barely visible.

Request door at the end of preheat

ON by default.

If set on OFF the oven will proceed with the cooking without notifying the user of end of the preheating

82 ▶ BUZZER

The following can be set:

- the **duration** of the buzzer at the end of the cooking cycle in seconds. Set the value using the keypad and confirm with "OK";
- the **volume** of the buzzer at the end of the cooking cycle, choosing from: high, medium or low;
- activation (ON) or deactivation (OFF) of an **optional external acoustic indicator**, if fitted.

83 ▶ AUTOCOOK

Add the list of programs for a specific country to the list of saved UNOX chef programs.

With every update recipes from all over the world are added to AUTOCOOK. Select here you country or try one of the other regional menus.



82



83

UNOX SERVICE

84 ► Here you will find the telephone numbers to be contacted for customer services.

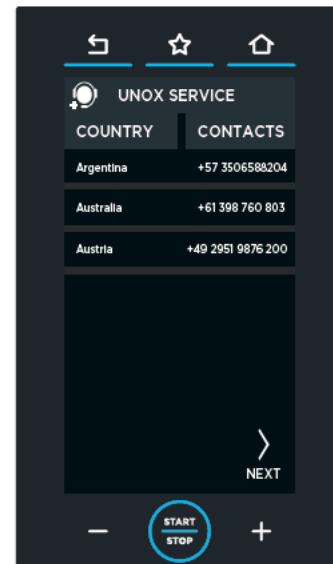

84

DEVICE INFO

85 ► This screen contains device information such as the model, the serial number, firmware number of the boards and the accessories

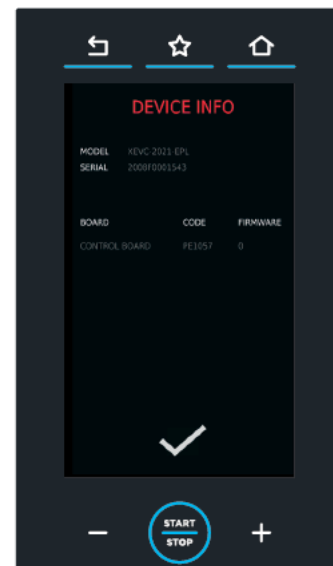

85

Alarms & Warnings | Oven user interface

The ovens show on display any alarm/warning messages relating to the oven or installed accessories on the screen.

The **warning messages (WARNING)** signal malfunctions that allow the appliance/accessories to continue operating, but with a restricted set of functions.

The **alarm messages (ALARM)** identify issues that prevent any operation whatsoever of the appliances/accessories, which therefore must be put into STOP mode.

If the alarm messages refer to the connected accessories, the oven can still be used.

If the AF23 - GAS REARM shows, this means there is no gas supply. In this case, contact an authorised support service, calling the number on the display (UNOX SERVICE). If you press the "IGNORE" button, a warning screen is shown. If you ignore the alarm, the oven cannot be used. If you press the "OTHER N°" button, a list of additional support service numbers is shown.

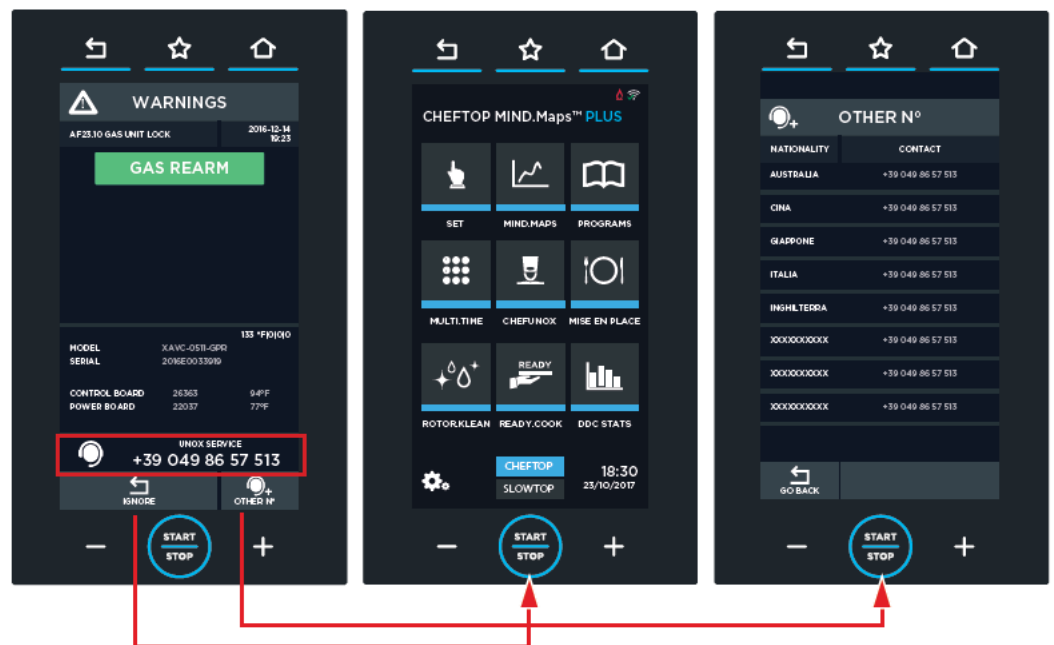

Maintenance

Safety information for maintaining the appliance	78
Cleaning the appliance	79
Inactivity	80
Disposal	80
Certification	81

SAFETY INFORMATION FOR MAINTAINING THE APPLIANCE

- ⚠ Any routine maintenance procedure must be performed:
 - after disconnecting the appliance from the power supply and waiting for the capacitive components to discharge (approx. a few minutes);
 - after waiting for the appliance to cool down fully;
 - only if you are in good mental and physical condition, and are wearing suitable personal protective equipment (e.g. heat-resistant rubber gloves, eye protection, dust mask (optional), etc.).

Clean the appliance on a daily basis in order to maintain a good level of hygiene and to prevent the stainless steel from corroding or deteriorating.

- ⚠ Daily cleaning also reduces the possibility of accumulated fatty substances or food residues inside the cavity catching fire and becoming a fire hazard.

When cleaning any component or accessory NEVER use:

- abrasive, pointy or sharp tools or cloths (abrasive sponges, scrapers, steel-bristled brushes, etc.);
- steam or pressurised water jets;
- abrasive or powder detergents;
- alkaline, aggressive, caustic or corrosive detergents (e.g. hydrochloric/muriatic or sulphuric acid or caustic soda). These substances could cause permanent damage to the appliance surfaces and catalysts.

- ⚠ Do not use these substances even when cleaning the appliance substructure or the floor under the appliance. The volatile emissions from these compounds may still cause damage.

CLEANING THE APPLIANCE

External steel structures, oven cavity seal, core probe

 Wait for the surfaces to cool off.
Use only a soft cleaning cloth dampened with a little soap and water. Rinse and dry completely. Alternatively, only use detergents recommended by UNOX; other products may cause damage, thereby invalidating the warranty*. Read the usage instructions provided by the detergent manufacturer.

Inside the oven cavity

 **Failure to clean the oven cavity daily can cause the accumulated grease and food residues inside to catch fire - this is a fire hazard.**
Use the washing cycle programs to clean the oven cavity.

 For more details, see ► p. 59



When the end is closed with the plug DO NOT use the wash cycle or wash the chamber with large amounts of water as this could cause flooding.

Plastic surfaces and control panel

 Wait for the surfaces to cool off. Use only a very soft cleaning cloth and a small amount of detergent for cleaning delicate surfaces.

Oven door internal and external glass

 Wait for the surfaces to cool off.
Use only a soft cleaning cloth dampened with a little soapy water or detergent specifically designed for glass. Rinse and dry completely.



87

INACTIVITY

During periods of inactivity, take the following precautions:

- disconnect the power, water and gas supplies to the appliance (ONLY FOR GAS OVENS);
- preferably rub a soft cloth lightly doused with mineral oil on all stainless steel surfaces;
- keep the appliance door slightly ajar.

Before reusing the appliance:

- clean the appliance and its accessories thoroughly (see page 79);
- reconnect the appliance to the power, water and gas supplies (GAS ONLY FOR GAS OVENS);
- inspect the appliance before using it again;
- switch on the appliance at minimum temperature for 50 minutes without any food inside it.

 To ensure that the appliance is in perfect condition in terms of use and safety, maintenance and inspections should be performed at least yearly by an authorised support service centre.

DISPOSAL

Pursuant to Article 13 of Italian Legislative Decree no. 49 (2014) "Implementation of the WEEE Directive 2012/19/EU on electrical and electronic equipment waste":

 The crossed-out wheeie bins symbol indicates that the product was placed on the market after 13 August 2005 and that, at the end of its useful life, it should not be disposed of with other waste, but must be collected separately.

All appliances are made with recyclable metal materials (stainless steel, iron, aluminium, galvanized steel, copper, etc.) in percentages above 90% by weight.

Before disposal, make the appliance unusable by removing the power cable and all compartment or cavity closure devices (where present).

At the end of its useful life, the product must be disposed of in such a way as to reduce any negative impact on the environment and make efficient use of available resources. Prefer prevention, preparation for reuse, recycling and reclamation, and remember "the polluter pays". Please remember that illegal or incorrect disposal of the product incurs penalties, as provided for by current legislation.

Information on disposal in Italy

In Italy, WEEE appliances must be delivered to:

- recycling centres (also known as waste disposal sites/facilities)
- the dealer from whom a new appliance is purchased, who is required to collect them free of charge ("one-for-one" exchange);

Information on disposal in European Union countries

The EU Directive on WEEE appliances has been implemented differently by each country. Therefore, if you want to dispose of this appliance, we recommend you contact your local authorities or dealer for information on the correct disposal method.

CERTIFICATION

EU declaration of conformity for electrical and gas appliances

Manufacturer: UNOX S.p.A.

Address: Via Majorana, 22 - 35010 Cadoneghe, Padua, Italy

declares, under its own responsibility, that the product

CHEFTOP-BAKERTOP MIND.Maps™

For electric and gas ovens:

complies with the Machinery Directive 2006/42/EC through the following standards:

EN 60335-1: 2014 + A11:2014

EN 60335-2-42: 2003 + A1: 2008 + A11:2012

EN62233: 2008

EN 60335-2-102:2006 + A1:2010

complies with the Electromagnetic Compatibility Directive 2014/30/EC through the following standards:

EN 55014-1: 2006 + A1: 2009 + A2: 2011

EN 55014-2: 1997 + A1: 2001 + A2: 2008

EN 61000-3-2: 2006 + A1: 2009 + A2: 2009

EN 61000-3-3: 2008

EN 61000-3-11: 2000

EN 61000-3-12: 2011

EN 61000-6-2: 2005

EN 61000-6-3: 2007

Only for gas ovens:

it complies with GAR (EU) Regulations 2016/426 through standards:

EN 203-1: 2014 / EN 203-2-2: 2006

Support

After-sales assistance

82

AFTER-SALES ASSISTANCE

In case of any malfunctions, disconnect the appliance from the power supply and consult the solutions proposed in the table **H | Troubleshooting** on page **83**.

If the solution is not listed in the table, contact an authorised UNOX technical service centre, providing the following information:

- date of purchase;
- **88** ► the appliance data on the serial plate;
- any warning messages that appear on the display.

Manufacturer's information:

UNOX S.p.A.

Via Majorana, 22

35010 Cadoneghe (PD), Italy

Tel. (+39) 049 8657511 - Fax (+39) 049 8657555

info@unox.com www.unox.com

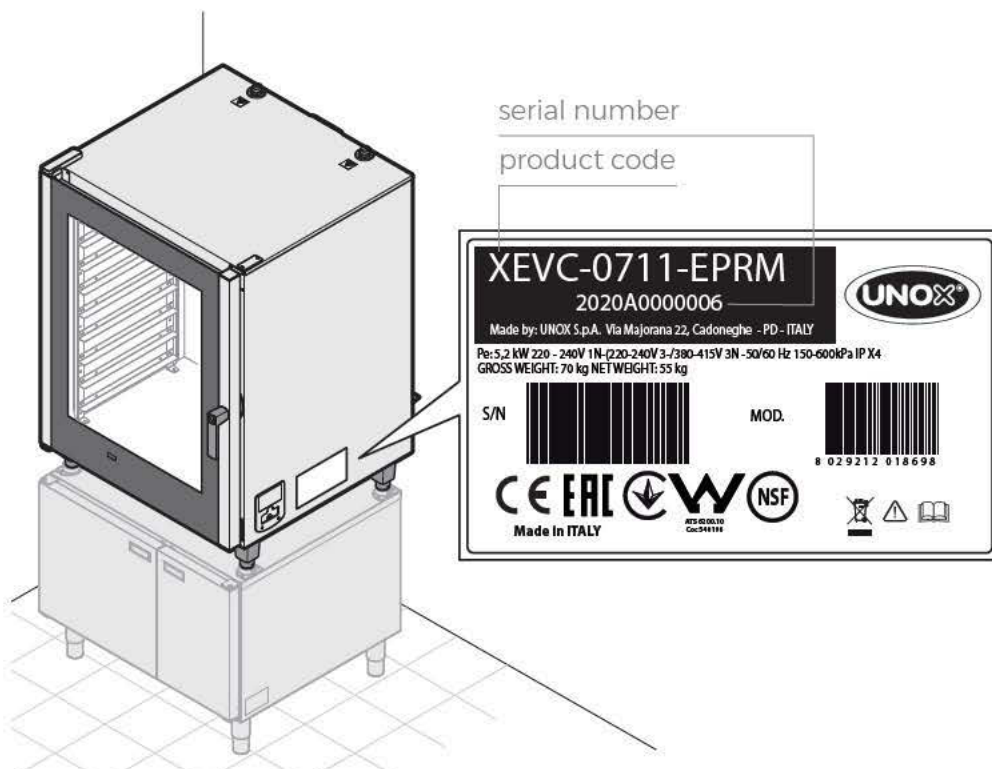

H | Troubleshooting

Fault	Possible cause	Possible solution	Solution
The oven is completely switched off.	<ul style="list-style-type: none"> ■ No mains power. ■ Appliance out of order. 	Make sure the appliance is connected to the electricity mains.	Contact the Customer Assistance Service.
No steam is produced inside the oven cavity.	<ul style="list-style-type: none"> ■ Water inlet closed. ■ Appliance plumbed into the water mains or the tank incorrectly. ■ No water in the tank (if water is taken from the tank). ■ Water supply filter clogged with impurities. 	<ul style="list-style-type: none"> ■ Open water inlet. ■ Make sure the appliance is plumbed into the water mains or the tank correctly. ■ Fill the tank with water. ■ Clean the filter. 	Contact the Customer Assistance Service.
After setting the time and pressing the START/STOP button, the oven does not start.	<ul style="list-style-type: none"> ■ Door open or not shut properly. 	<ul style="list-style-type: none"> ■ Make sure the door is shut. 	Contact the Customer Assistance Service.
Water escapes from the seal when the door is shut.	<ul style="list-style-type: none"> ■ Seal dirty. ■ Seal damaged. ■ The handle mechanism is loose. 	<ul style="list-style-type: none"> ■ Clean the seal using a damp cloth. ■ Contact a specialised technician for repairs. 	Contact the Customer Assistance Service.

UNOX App

Your virtual coach
TOP.TRAINING APP

Download the UNOX Top.Training App and enjoy the step-by-step learning to the secrets of the control panel of your new UNOX oven!



App Store



Google play



Create & share, understand, improve.
DATA DRIVEN COOKING

DATA DRIVEN COOKING allows you to control your oven at any time, anywhere. You can monitor its operating condition in real-time, create recipes and send them to your ovens. The AI transforms the consumption data into useful informations in order to increase your daily profit.



apple.com



play.google



INVENTIVE SIMPLIFICATION

EUROPE

IT - ITALIA UNOX S.p.a E-mail: info@unox.it Tel: +39 049 8657511	GB - UNITED KINGDOM UNOX UK Ltd. E-mail: info@unoxuk.com Tel: +44 1252 851 522	CZ - ČESKÁ REPUBLIKA UNOX DISTRIBUTION s.r.o. E-mail: info.cz@unox.com Tel: +420 241 940 000	BG - БЪЛГАРИЯ UNOX BULGARIA E-mail: info.bg@unox.com Tel: +359 2 419 05 00	NL - NETHERLANDS UNOX NETHERLANDS B.V. E-mail: info.nl@unox.com Tel: +31 6 27 21 14 10
DE - DEUTSCHLAND UNOX DEUTSCHLAND GMBH E-mail: info.de@unox.com Tel: +49 2951 98760	IE - IRELAND UNOX IRELAND E-mail: info.ie@unox.com Tel: +353 (0) 87 32 23 218	HR - HRVATSKA UNOX CROATIA E-mail: narudzbe@unox.com Tel: +39 049 86 57 538	AT - ÖSTERREICH UNOX ÖSTERREICH GMBH E-mail: info.de@unox.com Tel: +43 800 880 963	PL - POLSKA Unox Polska Sp. z o.o. E-mail: info.pl@unox.com Tel: +48 665 232 000
FR - FRANCE, BELGIUM & LUXEMBOURG UNOX FRANCE s.a.s. E-mail: info.fr@unox.com Tel: +33 4 78 17 35 39	ES - ESPAÑA UNOX PROFESIONAL ESPAÑA S.L. E-mail: info.es@unox.com Tel: +34 900 82 89 43	TR - TÜRKİYE - UNOX TURKEY Profesyonel mutfak ekipmanları endüstri ve ticaret limited şirketi E-mail: info.tr@unox.com Tel: +90 530 176 62 03	RU - РОССИЯ, ПРИБАЛТИКА И СТРАНЫ СНГ UNOX РОССИЯ E-mail: info.ru@unox.com Tel: +7 (499) 702 - 00 - 14	SC - SCANDINAVIAN COUNTRIES UNOX SCANDINAVIA AB E-mail: info.se@unox.com Tel: +46(0)790 75 63 64
PT - PORTUGAL UNOX PORTUGAL E-mail: info.pt@unox.com Tel: +351 918 228 787				

AMERICA

US - U.S.A. & CANADA UNOX Inc. E-mail: info.usa@unox.com Tel: +1 800 489 8669	AR - ARGENTINA UNOX ARGENTINA E-mail: info.ar@unox.com Tel: +54 911 37 58 43 46	CO - COLOMBIA UNOX COLOMBIA E-mail: info.co@unox.com Tel: +57 350 65 88 204	BR - UNOX BRASIL SERVICOS LTDA. E-mail: info.br@unox.com Tel: +55 11 98717-8201	MX - MEXICO UNOX MEXICO, S. DE R.L. DE C.V. E-mail: info.mx@unox.com Tel: +52 55 8116-7720
---	---	---	---	---

ASIA, OCEANIA & AFRICA

ZA - SOUTH AFRICA UNOX SOUTH AFRICA E-mail: info.sa@unox.com Tel: +27 845 05 52 35	PH - PHILIPPINES UNOX PHILIPPINES E-mail: info.asia@unox.com Tel: +63 9173108084	AU - AUSTRALIA UNOX AUSTRALIA PTY Ltd. E-mail: info@unoxaustralia.com.au Tel: +61 3 9876 0803	UZ - UZBEKISTAN UNOX PRO LLC E-mail: info.uz@unox.com Tel: +998 90 370 90 10	KR - 대한민국 UNOX KOREA CO. Ltd. 이메일: info.asia@unox.com 전화: +82 2 69410351
AC - OTHER ASIAN COUNTRIES UNOX (ASIA) SDN. BHD E-mail: info.asia@unox.com Tel: +603-58797700	TW - TAIWAN, HONG KONG & MACAU UNOX TAIWAN E-mail: info.tw@unox.com Tel: +886 928 250 536	MY - MALAYSIA & SINGAPORE UNOX (ASIA) SDN. BHD E-mail: info.asia@unox.com Tel: +603-58797700	CN - 中华人民共和国 UNOX TRADING (SHANGAI) Ltd. CO. 电子邮件: info.asia@unox.com 电话: +603-58797700	NZ - NEW ZEALAND UNOX NEW ZEALAND Ltd. E-mail: info@unox.co.nz Tel: +64 (0) 800 76 0803
AE - U.A.E. UNOX MIDDLE EAST DMCC E-mail: info.uae@unox.com Tel: +971 4 554 2146	ID - INDONESIA UNOX INDONESIA E-mail: info.asia@unox.com Tel: +62 81908852999			

unox.com



L12450A0

All images used are for illustrative purposes only.
All features indicated in this catalogue may be subject to change and could be updated without notice.