



BAKERLUX SHOP.Pro™ Go  
BAKERLUX SHOP.Pro™ Led

OPERATION MANUAL

# BAKERLUX SHOP.Pro™

Dear Customer,

We thank you for having purchased an oven / complementary accessory from the **BAKERLUX SHOP.Pro™** line.

These ovens are the result of Unox's research and warranty minimum occupation of space with excellent performance while offering outstanding cooking management under any condition of use and load.

The **BAKERLUX SHOP.Pro™** ovens use UNOX's finest patented technology, which is the result of collaborations with master chefs and the world's leading research institutions.

A wide array of available accessories make these ovens extremely versatile and streamline everyday kitchen duties.

## INDEX

<b>SAFETY REGULATIONS FOR USE</b> .....	<b>4</b>
<b>GENERAL OPERATING INSTRUCTIONS</b> .....	<b>5</b>
Cooking/leavening advice.....	5
<b>USE: THE CONTROL PANEL</b> .....	<b>6</b>
<b>USE: SOME CONCEPTS</b> .....	<b>7</b>
manual and automatic cooking.....	7
What are cooking steps?.....	7
how to set values?.....	7
<b>MANUAL COOKING</b> .....	<b>8</b>
guided use procedure (GO version).....	8
guided use procedure (LED version) .....	10
<b>AUTOMATIC COOKING</b> .....	<b>12</b>
changing a saved recipe.....	13
<b>USING THE PROVER (ONLY THE LED VERSION)</b> .....	<b>14</b>
<b>ALARMS</b> .....	<b>15</b>
<b>ORDINARY AND AFTER-SALES MAINTENANCE</b> .....	<b>16</b>
External steel structures, oven cavity seal .....	16
internal part of the oven cavity.....	16
plastic surfaces and control panels.....	16
Inside and outside oven door window glass .....	16
after-sales assistance .....	17
<b>AFTER-SALES ASSISTANCE</b> .....	<b>17</b>

- Following procedures other than those indicated in this manual to use and clean the appliances is considered inappropriate and may cause damage, injury or death; in addition to invalidating the warranty\* and relieving UNOX of all liability.
- Children must not play with the appliance. Cleaning and maintenance to be implemented by the user must not be carried out by children without supervision.
- Children must be supervised to ensure they do not play with the appliance.
- This appliance can only be used by qualified personnel, who have completed scheduled training courses, for cooking food in industrial and professional kitchens. All other uses are not compliant with the scope of use and are therefore hazardous.
- If the appliance does not function or if you notice any functional or structural alterations, disconnect the electricity and water supplies and contact a UNOX authorised customer assistance service. Do not attempt to repair the appliance yourself. Request UNOX original spare parts for any repairs.
- Failure to observe these regulations may cause damage, injury or death, and also invalidates the warranty\*.
- To ensure that the appliance is in perfect condition in terms of use and safety, maintenance and inspections should be performed yearly by an authorised support service centre.
- When navigating and setting parameters only use your dry and clean finger, avoid the use of tools such as forks, spoons, etc.



### **RISK OF BURNS AND INJURY!**

- While cooking and during cooling of all appliance parts, be careful to only touch the appliance control components or handle because the external parts are extremely hot (temperature above 60°C (140°F)).
- Open the door (where necessary) slowly and with the utmost caution, while being careful of extremely hot steam released from the oven cavity.
- Wear heat-resistant clothing appropriate to the use at hand to move containers, accessories and other objects inside the oven cavity.
- Be extremely careful when removing trays from the oven cavity.
- Do not remove or touch the protective fan covering, the fans or the heating elements while the appliance is turned on.
- For no reason should the water circuit of the oven be tampered with because this could cause damage, injury or death. The water circuit of the oven begins with a 3/4" fitting, with a built-in non-return valve, and includes all the piping and accessories downstream of this.



### **RISK OF FIRE!**

- Before using the appliance, make sure that there are no non-compliant objects (instruction manuals, plastic bags, etc.) or detergent residue inside the oven cavity. Also make sure that the flue is free of obstructions and that there are no flammable materials in the vicinity.
- Do not place sources of heat (e.g. grills, fryers, etc.), highly flammable substances or fuels (e.g. gasoline, petrol, bottles of alcohol, etc.) in the vicinity of the appliance.
- Do not use highly flammable food or liquids while cooking (e.g. alcohol).
- Always keep the oven cavity clean, performing daily cleaning after each cooking cycle: fats or food residue left inside the appliance could ignite!



### **RISK OF ELECTRIC SHOCK**

- Do not open the compartments marked with these symbols: access is reserved to qualified personnel authorised by UNOX. Failure to observe this regulation invalidates the warranty\* and may cause damage or (fatal) injuries.

 **Before using the appliance carefully read the section “Safety regulations for use”**

- When using the appliance for the first time, be sure to clean the inside of the oven cavity and the accessories thoroughly (see page 16); let the oven run empty at maximum temperature for 1 hour to eliminate any unpleasant odours caused by protective factory grease.
- If the appliance was left running for more than 15 minutes without selecting an operating mode, stand-by is automatically engaged for energy savings. To exit STAND-BY MODE, simply touch the START/STOP button.
- Operate the appliance at a room temperature between +5°C and +35°C.
- In the event of a black-out or shut down of the machine, on restart the appliance resumes the programme previously in progress. The duration of the cooking cycle may be extended by a maximum of 2 minutes.
-  For safety reasons, the last tray should NEVER be placed at a height greater than 160 cm. If necessary to do so, **it is mandatory to post the sticker contained in the “Starter Kit” at the height of 160 cm.**

### COOKING/LEAVENING ADVICE

- Use the UNOX grills and trays. Try to distribute food uniformly on the trays while avoiding stacking and overloading with excessive quantities.
- Do not salt food inside the oven cavity. If this is not possible, clean the oven as soon as possible.
- Do not use highly flammable food or liquids while cooking (e.g. alcohol or wine).
- It is always better to preheat the oven to a temperature at least 30°C higher than is required for cooking, in order to reduce the effects of heat lost when opening the door.
- Open the door as little as possible when cooking.
- Try to evenly place the food on the trays, avoid overlapping food or overloading the trays with food (maximum 10 kg per tray). Distribute the trays evenly over the entire height of the oven cavity, respecting the maximum number indicated for each appliance.
- Always respect the loading instructions for your oven..
- Take care when touching the external and internal parts of the oven during cooking and until the complete cooling (it could reach temperatures above 60°C).
- To prevent boiling, do not fill containers with liquids or foods that liquefy with heat in quantities exceeding those that can easily be kept under control.

When navigating and setting parameters only use your dry and clean finger, avoid the use of tools such as forks, spoons, etc.

# BAKERLUX SHOP.Pro™

Use: the control panel

Model **GO**

Preheating step — PRE 1 2 3 — Cooking steps;

Setting the cooking duration — [Clock icon] [Duration display] [Temperature icon] — Set temperature

Programs with recipes already stored  
**automatic cooking**

A) Start cooking  
B) The machine turns off if pressed for 5 seconds

START STOP

GO

manual cooking settings

Model **LED**

Preheating step — PRE 1 2 3 — Cooking steps;

Set temperature — [Temperature display] — Set steam

Setting the cooking duration — [Clock icon] [Temperature icon] [Fan icon] — Setting fan speed

Programs with recipes already stored  
**automatic cooking**

A) Start cooking  
B) The machine turns off if pressed for 5 seconds

Oven selection — [Oven icon] — Proofer selection

START STOP

LED

manual cooking settings

With the "LED" models it is possible to check if the oven and proofer are connected by acting on a single control panel.





When you want to use the oven, touch the "OVEN SELECTION" icon on the left, to use the proofer touch the "PROOFER SELECTION" icon on the right.

Then continue as normal.

### MANUAL AND AUTOMATIC COOKING

The oven you purchased can carry out either **manual** or **automatic** cooking.

During **manual cooking**, the user, based on experience, must set the following cooking parameters for one or more cooking steps (up to a maximum of three):

-  **cooking time** (in hours.minutes);
-  **temperature** in the oven cavity (°C);
-  **steam input** (only LED version ovens);
-  **fan speed** (only LED version ovens).

During the **automatic cooking**, recipes pre-set by the Manufacturer or previously stored by the user after setting them manually are used.



The oven can hold up to 99 recipes (from P1 to P99).

NE

### WHAT ARE COOKING STEPS?

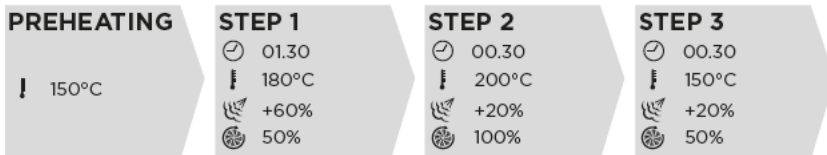
Each manual cooking is made up of an **initial preheating** ("PRE" - optional but always recommended) and cooking **steps** (from a minimum of 1 and a maximum of 3), each featuring different cooking parameters. Set multiple cooking steps instead of one only, it allows for a proper balance between temperature, cooking time and humidity: this translates into better results.



-  To enable use, a cooking cycle must contain at least one STEP.
-  Cooking does not necessarily require all steps: set only those steps which are required.
-  The appliance automatically passes from one STEP to the next.

### HOW TO SET VALUES?

#### GO model



#### LED model



Values are set:





- ① by pressing the "+" and "-" buttons until the desired value is reached;
- ② by using the "scroll" function, or rather, by sliding your finger over the bar (GO version) or over the display (LED version). In this latter case advancement will be faster.



# BAKERLUX SHOP.Pro™

## Manual cooking

During **manual cooking**, the user, based on experience, must set the following cooking parameters for one or more cooking steps (up to a maximum of three):

-  **cooking time** (in hours.minutes);
-  Oven cavity **temperature** (°C)
-  **steam** input (only LED version ovens);
-  **fan speed** (only LED version ovens).

After setting the cooking parameters (duration, temperature, etc.), you can start cooking directly or save the set recipe: this will allow you to reuse it every time you want, without having to reset the parameters each time.

### GUIDED USE PROCEDURE (GO VERSION)

#### A SET PREHEATING (OPTIONAL)

- 1 Select the "PRE" icon if you want to set a preheating.
- 2 Set the desired temperature value for the preheating (we recommend a temperature that is 30°C more than the temperature used for cooking).



#### B SETTING COOKING PARAMETERS

- 3 Select icon "1": it is now possible to set the parameters of cooking STEP "1".

 **For more information on cooking steps see page 7**

- 4 Select the "CLOCK" icon to set the **cooking time**.
- 5 Set the desired value in hours.minutes (the example shows one hour and thirty minutes).
- 6-7 Use the method to set the cooking time to insert the

 the oven cavity **temperature** (from....to....°C);

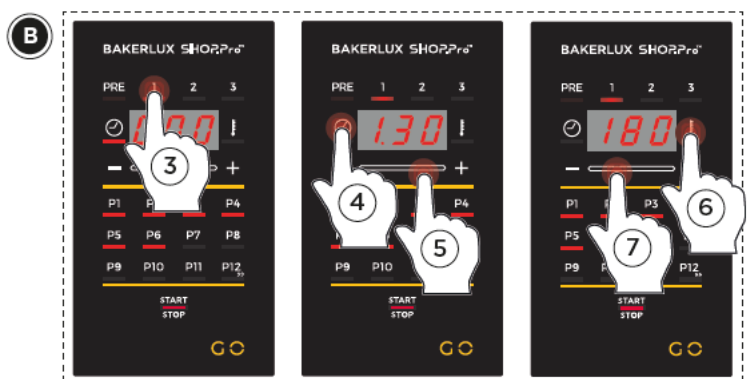

#### C SET THE NEXT STEPS (OPTIONAL)

If needed, repeat the operations from point 3 to point 6 to set cooking STEPS "2" and "3".

Warning, at point 3 touch icon "2" to set STEP "2" and icon "3" to set STEP "3".

- 3 Repeat these steps to set STEP 2 and 3 (if needed)





## D STARTING COOKING/SAVING COOKING

After having set the cooking parameters (duration and time), you can:

- directly start the cooking: at the end of cooking the set parameters will NOT be saved;
- save the set cooking and then start cooking: at the end of cooking, the set parameters are saved and the recipe can be used again subsequently whenever needed without having to pre-set the parameters each time.

### Directly start cooking

- 1A Press the "START/STOP" icon: cooking starts with the set parameters and all the red LEDs of the positions turn off.

### Save cooking and then start it

- 1B If you want to save the recipe before starting it, search for a free position by looking at the LEDs:

free position: LED not turned on (e.g. P7)

occupied position: LED turned on (e.g. from P1 to P6), however, if you select this although it is occupied, you will overwrite the recipe already found and will delete it irreversibly.

**Note:** to select positions from P12 to P99, press P12 for 5 sec. (it will start flashing), press the "+" key repeatedly until the screen shows the desired position, press it for 5 seconds. to save the recipe.

- 2B Press the selected button for 5 seconds: you will hear an acoustic signal indicating that the cooking is saved.
- 3B Press the "START/STOP" icon to start cooking.

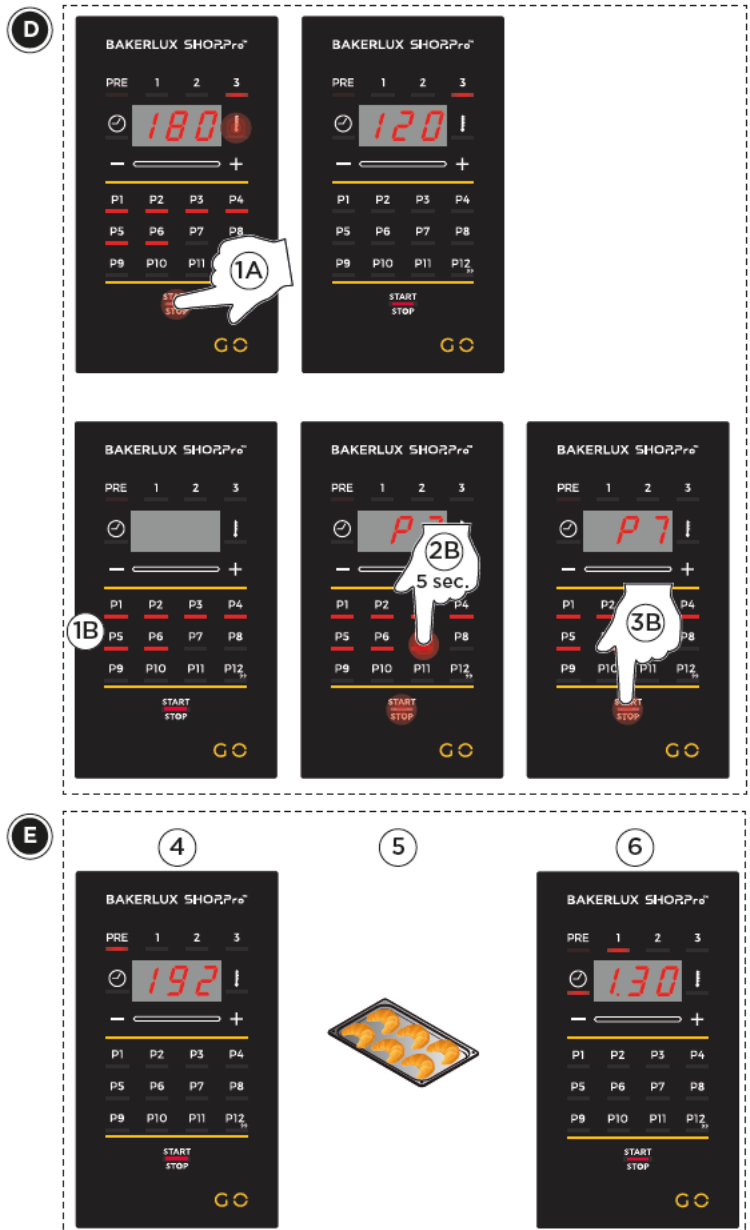

## E COOKING IN PROGRESS!!!!

- 4 If the cooking requires a pre-heating, the oven starts to heat the oven cavity to bring it to the set temperature (in the example 192°C). DO NOT place the dishes in the oven during this phase.

- 5 At the end of the preheating, the oven emits a beep and the oven LED light flashes: it is time to cook the dishes. When the door is closed, STEP 1 automatically starts according to the set parameters.

- 6 During cooking the set parameters are seen on the screen when the icon of interest it touched:



shows the set cooking **time** alternating with the time remaining until the end of cooking;



shows the set oven cavity **temperature** alternating with the current temperature.

The set temperatures can be changed at any time by acting as explained on the previous page (points from 3 to 6). Cooking ends at the end of the set time, if you want to interrupt cooking before the end of the set time, hold down the "START/STOP" button.

## F COOKING END

At the end of the cooking, the oven emits an acoustic signal and the oven light flashes: the dishes are ready. The light turns off when the door is opened.

## GUIDED USE PROCEDURE (LED VERSION)

### A SELECT THE APPLIANCE

- 1 Select the "OVEN" icon: the control panel is now enabled to use this appliance.



### B SET PREHEATING (OPTIONAL)

- 2 Select the "PRE" icon if you want to set a preheating.
- 3 Set the desired temperature value for the preheating (we recommend a temperature that is 30°C more than the temperature used for cooking).



### C SETTING COOKING PARAMETERS

- 4 Select icon "1": it is now possible to set the parameters of cooking STEP "1".

 **For more information on cooking steps see page 7**

- 5 Select the "CLOCK" icon to set the cooking time.
- 6 Set the desired value in hours.minutes (the example shows one hour and thirty minutes).
- 7...11 Use the method to set the cooking time to insert the values for:

 oven cavity **temperature**  
(from....to....°C);

 **steam input**  
(from ....to....with shots of 20);

 **fan speed** (1: reduced speed; 2: maximum speed).

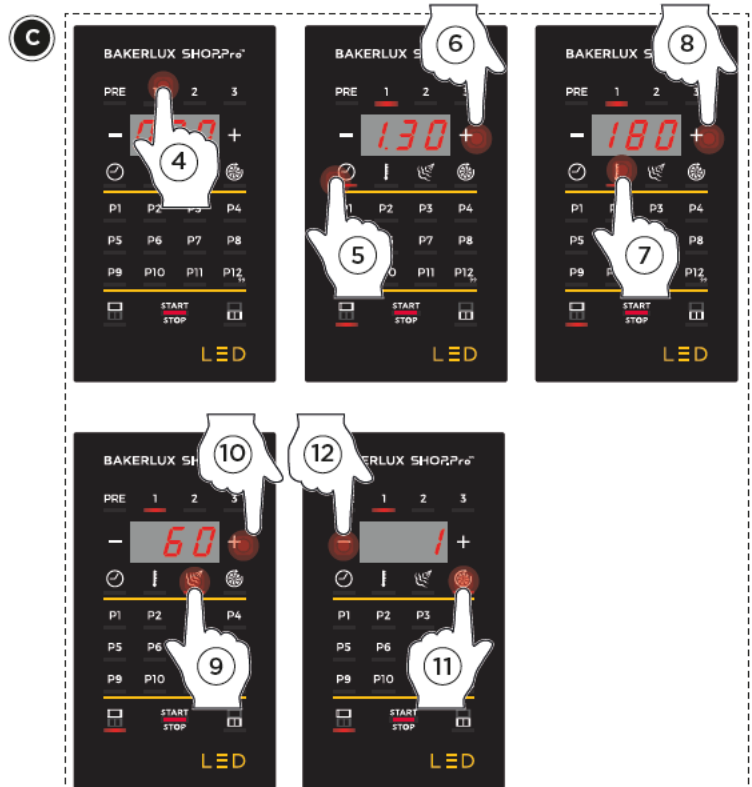

### D SET THE NEXT STEPS (OPTIONAL)

If needed, repeat the operations from point 4 to point 11 to set cooking STEPS "2" and "3".

Warning, at point 4 touch icon "2" to set STEP "2" and icon "3" to set STEP "3".

- D Repeat these steps to set STEP 2 and 3 (if needed)



## E START/SAVE COOKING

After having set the cooking parameters (duration, time, etc...), you can:

- directly start the cooking: at the end of cooking the set parameters will NOT be saved;
- save the set cooking and then start cooking: at the end of cooking, the set parameters are saved and the recipe can be used again subsequently whenever needed without having to pre-set the parameters each time.

### Directly start cooking

- 1A Press the "START/STOP" icon: cooking starts with the set parameters and all the red LEDs of the positions turn off.

### Save cooking and then start it

- 1A If you want to save the recipe before starting it, search for a free position by looking at the LEDs:

free position: LED not turned on (es. P7)

occupied position: LED turned on (e.g. from P1 to P6), however, if you select this although it is occupied, you will overwrite the recipe already found and will delete it irreversibly.

**Note:** to select positions from P12 to P99, press P12 for 5 sec. (it will start flashing), press the "+" key repeatedly until the screen shows the desired position, press it for 5 seconds. to save the recipe.

- 2B Press the selected button for 5 seconds: you will hear an acoustic signal indicating that the cooking is saved.
- 3B Press the "START/STOP" icon to start cooking.

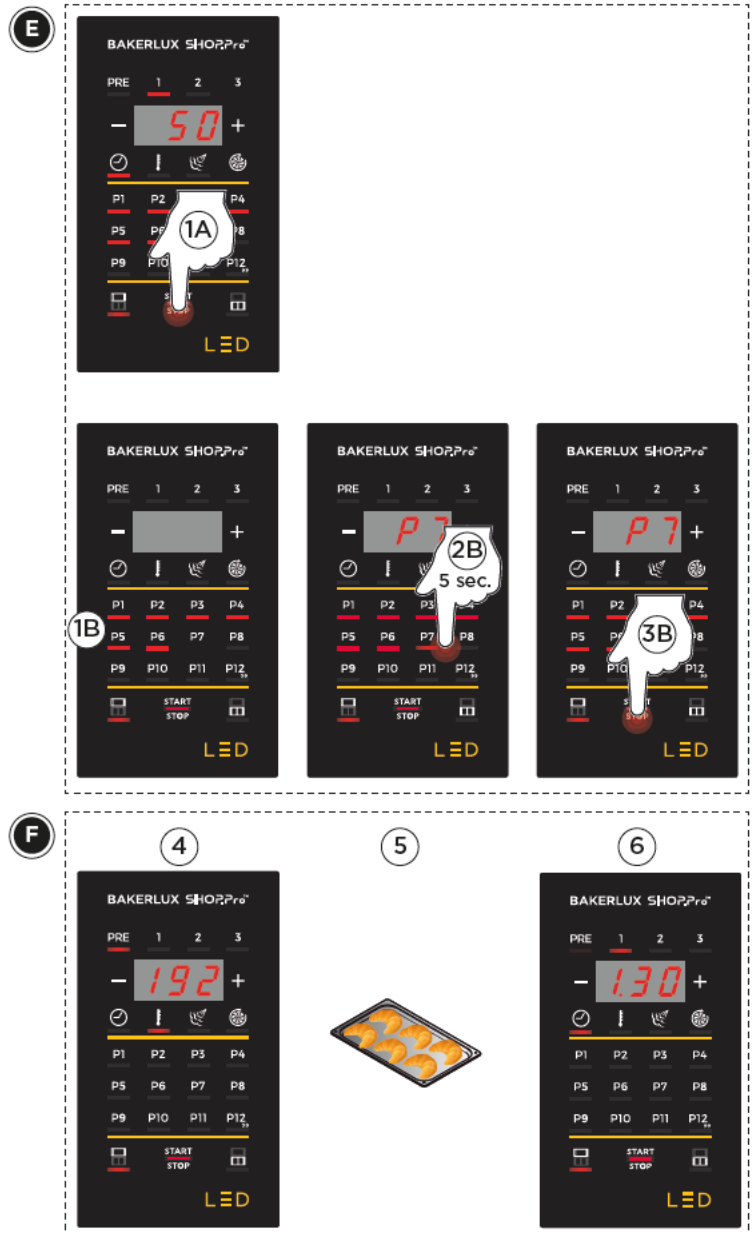

NE

## F COOKING IN PROGRESS!!!!

- 4 If the cooking requires a pre-heating, the oven starts to heat the oven cavity to bring it to the set temperature (in the example 192°C). DO NOT place the dishes in the oven during this phase.
- 5 At the end of the preheating, the oven emits a beep and the oven LED light flashes: it is time to cook the dishes. When the door is closed, STEP 1 automatically starts according to the set parameters.
- 6 During cooking the set parameters are seen on the screen when the icon of interest it touched:

 shows the set cooking **time** alternating with the time remaining until the end of cooking;

 shows the set oven cavity **temperature** alternating with the current temperature;

 shows the set **steam input**;

 shows the set **fan speed**.

The set temperatures can be changed at any time by acting as explained on the previous page (points from 4 to 11). Cooking ends when the set time has elapsed, if you want to interrupt cooking before the end of the set time, hold down the "START/STOP" button.

## G COOKING END

At the end of the cooking, the oven emits an acoustic signal and the oven light flashes: the dishes are ready. The light turns off when the door is opened.

# BAKERLUX SHOP.Pro™

## Automatic cooking

During the **automatic cooking**, recipes pre-set by the Manufacturer (if provided) or previously stored by the user after setting them manually are used (see previous pages).  
The oven can hold up to 99 recipes (from P1 to P99).

To return to "manual cooking" mode, after pressing any "P" button, you have to press the same button again; For example, if I press P1 to enter "automatic cooking" mode, pressing P1 again will return to "manual cooking" mode.

### CALLING UP A SAVED RECIPE

- ① Press the button of interest (to access positions from P13 to P99, select the P12 position and move forward with the "+" button): the corresponding LED starts flashing.
- ② Press the "START/STOP" icon: cooking starts with the set parameters and all the red LEDs of the positions turn off.  
Refer to the "Cooking in progress!!!" and "End of cooking" parts under the "Manual cooking" section.

It is recommended that you use the table below to find the recipe that is most relevant to you.

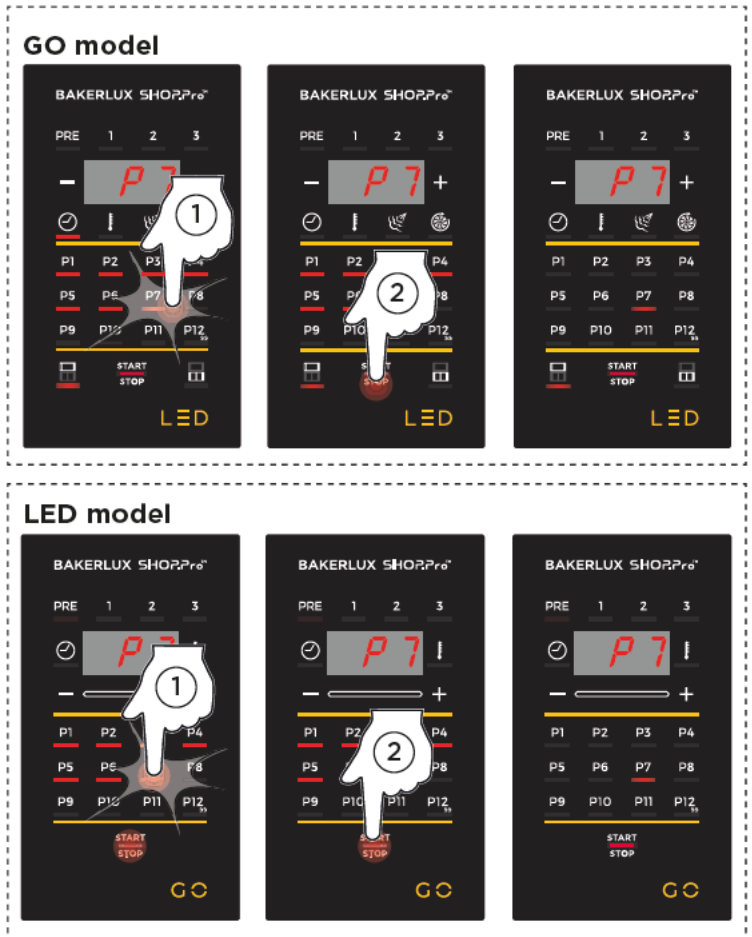

Pos.	Recipe name	PRE	STEP 1			STEP 2			STEP 3				
P1													
P2													
P3													
P4													
P5													
P6													
P7													
P8													
P9													
P10													
P11													
P12													
P13													



## CHANGING A SAVED RECIPE

- 1 Press the button corresponding to the program to be modified (in the example, P7): the LED starts flashing.

**Note:** to select positions from P12 to P99, press P12 (it will start flashing), press the "+" key repeatedly until the screen shows the desired position, press it for 5 seconds. to save the recipe.

- 2 Select the step to be modified (the example shows STEP "1").
- 3 Select the parameter to be modified (the example shows the temperature).
- 4 Insert the new value (the example shows how the temperature is brought from 180°C to 200°C).

Now you can:

- 5A **overwrite** the modified program. press the same key e.g. P7 for 5 seconds (the existing recipe is deleted irreversibly).  
In the example:

P7: program with temperature set to **200°C** (instead of 180°C as previously set).

- 5B **save** a new program identical to the initial program (e.g. P7), except for the changes made (in the example, a change to the temperature).

Press the button for the desired position again (e.g. P8) and hold for 5 seconds: if the name is shown in red, this means that the position is already occupied. If you chose the position anyway, this will overwrite the existing recipe, permanently deleting it.

In the example:

P7: program with temperature set to **180°C**

P8: program identical to P7, except the STEP 1 temperature has been set to **200°C**.

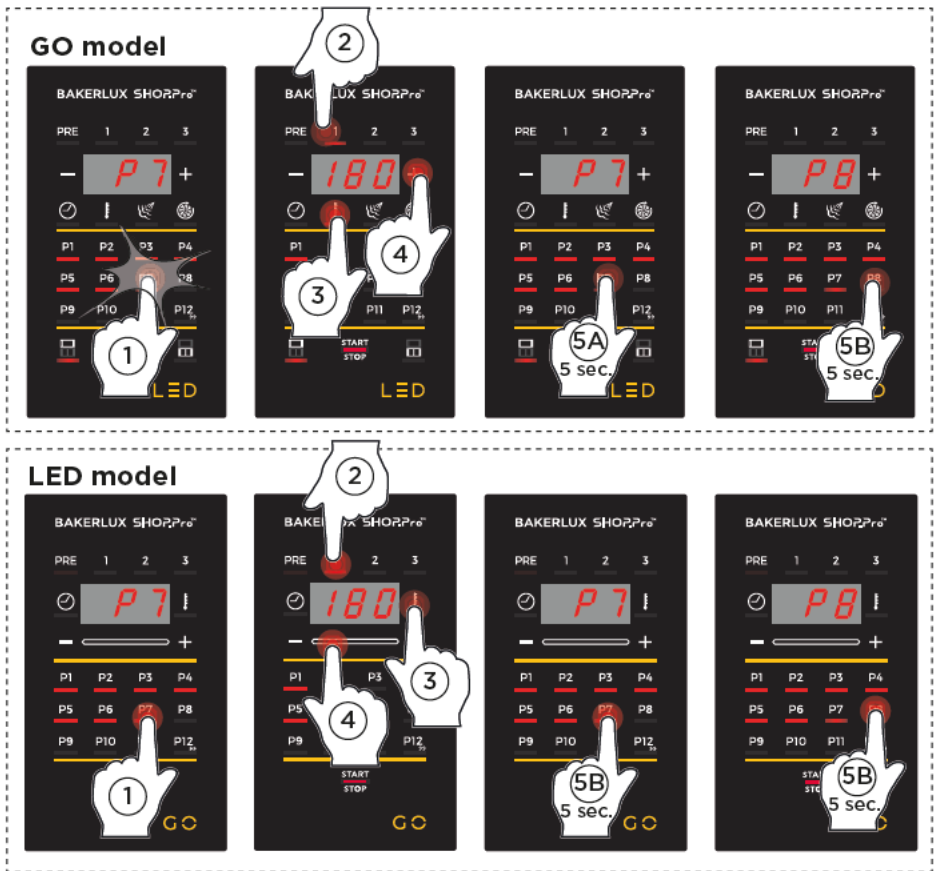

NE

Pos.	Recipe name	PRE	STEP 1			STEP 2			STEP 3				

# BAKERLUX SHOP.Pro™

Using the prover (only the LED version)

Your BAKERLUX SHOP.Pro™ LED version appliance can control a prover of the same series, connected thereto.

## A SELECT THE APPLIANCE

- 1 Select the "PROVER" button: the control panel is now enabled to use this appliance.

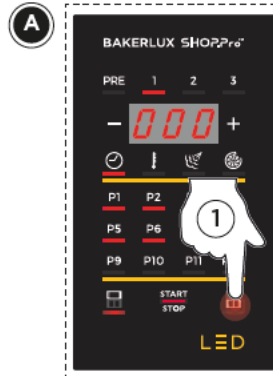

## B SETTING LEAVENING PARAMETERS

- 2 Select the "CLOCK" button to set the **leavening cycle time**.
- 3 Set the desired value in hours.minutes (the example shows 5 hours and 30 minutes).
- 4 Select the "TEMPERATURE" button to set the **leavening temperature**.
- 5 Set the desired value in °C (the example shows: 50°C).

Only for models with a boiler

- 6 Select the "HUMIDITY" button to set the **humidity during leavening** (steps of 20%).
- 7 Set the desired percentage value (in the example: 80= 80% humidity).

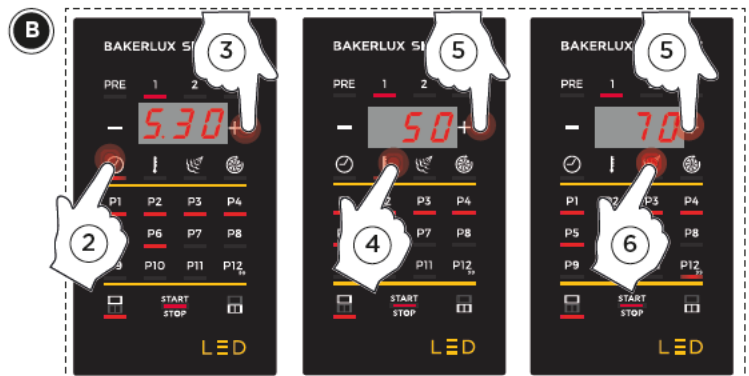

## C START LEAVENING

- 8 Press the "START/STOP" button: leavening will start with the set parameters.

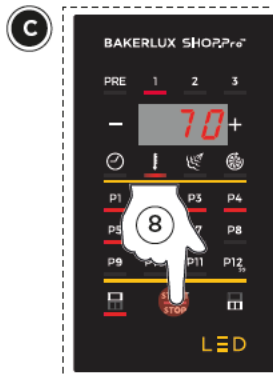

## D STEAM INPUT

- 9 Only for models without a boiler if steam needs to be added during the leavening process in progress, press the "STEAM" button: steam is injected until the button is released.

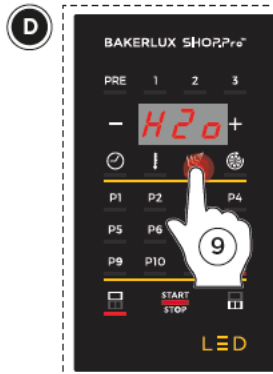

The ovens show alarm/warning messages relative to the oven or installed accessories (only LED version) on the screen.

The warning messages (WARNING) signal malfunctions that nevertheless allow the appliance and accessories to operate, though with a restricted set of functions.

The alarm messages (ALARM) identify situations that fail to allow any appliance/accessories operation whatsoever, and therefore must be put into STOP mode.

If the alarm messages strictly refer to the connected accessories, the oven can still be used.

<b>ALARMS</b>			
<b>Display</b>	<b>Description</b>	<b>Effect</b>	<b>Solution</b>
A01	Motor thermal alarm	The oven stops any operating cycle and blocks any screen display configuration	Contact the Customer Assistance Service
A02	Safety thermostat alarm		
A03	Oven cavity alarm		
A04	Hood communications failure alarm		
A07	Prover cavity probe alarm	The prover stops any operating cycle and stops any successive display screen settings	Check the power cord of the appliance, if the problem persists even after the corrective action, contact the customer assistance service
A08	Presence of prover power alarm		
A09	Prover communication alarm		

<b>WARNING</b>			
<b>Display</b>	<b>Description</b>	<b>Effect</b>	<b>Solution</b>
U01	Warning: oven temperature board	The appliance continues to operate, but some functions may be disabled	Contact the Customer Assistance Service
U07	Warning prover temperature board		
U13	Warning: hood temperature board		
U14	Warning: hood temperature board probe		
U15	AC power missing		
U16	Communication error		



-  **Any routine maintenance procedure must be performed:**
- **after disconnecting the appliance from the power and water supplies;**
  - **after having put on the proper personal protective equipment (gloves, etc.).**

Clean the oven cavity daily to maintain proper levels of hygiene and to keep the stainless steel inside the oven cavity from getting ruined or corroding.

When cleaning any component or accessory NEVER use:

- abrasive or powder detergents;
- aggressive or corrosive detergents (e.g. hydrochloric/muriatic or sulphuric acid). Caution! Never use these substances when cleaning the appliance substructure and floors either;
- abrasive or sharp tools (abrasive sponges, scrapers, steel bristled brushes, etc.);
- water jets.

## EXTERNAL STEEL STRUCTURES, OVEN CAVITY SEAL

**Wait for the surfaces to cool off.**

Use a soft cleaning cloth dampened with a little soap and water only. Rinse and dry completely.

## INTERNAL PART OF THE OVEN CAVITY

-  **Failure to clean the oven cavity daily can cause the accumulated fatty substances or food residues inside the cavity to catch fire – risk of fire!**

Clean the oven cavity **daily** to maintain high levels of hygiene and to preserve the brilliance of the steel and performance of the equipment through time. Fat particles or food residues may also catch fire during cooking, causing damage to people and the equipment. Cleaning should always be carried out with a cold oven cavity using a soft cloth soaked in warm soapy water. Finish cleaning by rinsing and thoroughly drying.

## PLASTIC SURFACES AND CONTROL PANELS

Use only a very soft cleaning cloth and a small amount of detergent for cleaning delicate surfaces. Follow the detergent manufacturer's directions.

## INSIDE AND OUTSIDE OVEN DOOR WINDOW GLASS

**Wait for the glass to cool off.**

Use only a soft cleaning cloth dampened with a little soap and water or specific glass cleaners. Rinse and dry completely.

-  **FOR OVENS WITH A FLAP DOOR: when cleaning the oven DO NOT remove the internal glass as it may break.**

## AFTER-SALES ASSISTANCE

In case of any malfunctions, disconnect the appliance from its power and water supply. Consult the solutions proposed in the table.

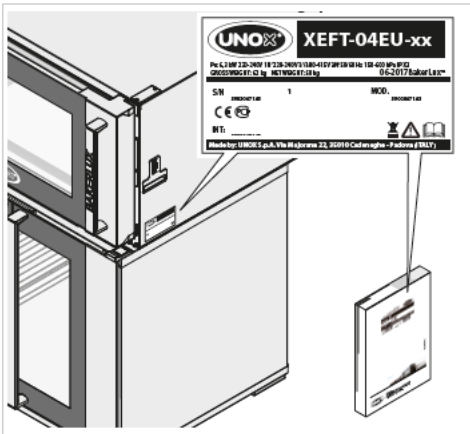

If the solution is not listed in the table, contact a technical service centre authorised by UNOX. Provide the following information:

- the date of purchase;
- the appliance data on the serial plate;
- any warning messages that appear on the display.

Manufacturer's information:

UNOX SpA

Via Majorana, 22

35010 Cadoneghe (PD) Italy

Tel +39 049 86.57.511 - Fax +39 049 86.57.555

info@unox.com www.unox.com

Malfunction	Possible cause	Possible solution	Solution
The oven is completely switched off.	<ul style="list-style-type: none"> <li>- No mains power.</li> <li>- Appliance out of order.</li> </ul>	Make sure the appliance is connected to the electricity mains.	Contact the Customer Assistance Service.
No steam is produced inside the oven cavity.	<ul style="list-style-type: none"> <li>- Water inlet closed.</li> <li>- Appliance plumbed into the water mains or the tank incorrectly.</li> <li>- No water in the tank (if water is taken from the tank).</li> <li>- Water supply filter clogged with impurities.</li> </ul>	<ul style="list-style-type: none"> <li>- Open water inlet.</li> <li>- Make sure the appliance is plumbed into the water mains or the tank correctly.</li> <li>- Fill the tank with water.</li> <li>- Clean the filter.</li> </ul>	
After the time has been set and the "START/STOP" button pressed, the oven does not start.	Door open or not shut properly.	Make sure the door is shut.	
Water escapes from the seal when the door is shut.	<ul style="list-style-type: none"> <li>- Seal dirty.</li> <li>- Seal damaged.</li> <li>- The handle mechanism is loose.</li> </ul>	<ul style="list-style-type: none"> <li>- Clean the seal using a damp cloth.</li> <li>- Contact a specialised technician to request repairs.</li> </ul>	

## INACTIVITY

During periods of inactivity, take the following precautions:

- disconnect the appliance from the power and water supplies;
- rub a soft cloth lightly doused with mineral oil on all stainless steel surfaces;
- keep the appliance door slightly ajar.

Before reusing the appliance:

clean the appliance and its accessories thoroughly (see the chapter "" on page 16);

- connect the appliance to the power and water supplies;
- inspect the appliance;
- switch on the appliance at minimum temperature for 50 minutes without any food inside of it.

 To ensure that the appliance is in perfect condition in terms of use and safety, maintenance and inspections should be performed yearly by an authorised support service centre.

## DISPOSAL

Pursuant to article 13 of Legislative Decree 49 of 2014 "Implementation of the WEEE Directive 2012/19/EU on electrical and electronic equipment waste":



The barred symbol of the rubbish bin specifies that the product was placed on the market after August 13, 2005 and that at the end of its useful life it should not be treated as other waste, but must be collected separately.

All appliances are made with recyclable metal materials (stainless steel, iron, aluminium, galvanized steel, copper, etc.) in percentages higher than 90% by weight.

Before disposal, make the appliance unusable by removing the power cable and any compartment or cavity closure device (where present).

At the end of its useful life, this product must be handled so as to reduce the negative impact on the environment and improve the efficiency of resource use by applying the principles of "the polluter pays", prevention, preparation for reuse, recycling and salvaging. Please remember that illegal or incorrect disposal of the product leads to the application of the penalties provided for by current legal provisions.

### Information on disposal in Italy

In Italy, WEEE appliances must be delivered to:

- recycling centres (also known as waste disposal sites/facilities)
- the dealer from whom new appliances are purchased, who is required to collect them free of charge ("one-for-one" collection);

### Information on disposal in European Union countries

The EU Directive on WEEE appliances has been implemented differently by each country. Therefore, if you want to dispose of this appliance, we recommend you contact your local authorities or dealer for information on the correct disposal method.

## CERTIFICATION

### EU declaration of conformity for electrical appliances

Manufacturer: UNOX S.p.A.

Address: Via Majorana, 22 - 35010 Cadoneghe, Padua, Italy

Declares, under its own responsibility, that the product

#### **BAKERLUX SHOP.Pro™**

complies with the Machinery Directive 2006/42/EC through the following standards:

EN 60335-1: 2014 + A1:2014

EN 60335-2-42: 2003 + A1: 2008 + A1:2012

EN62233: 2008

EN 60335-2-102:2006 + A1:2010

comply with the Electromagnetic Compatibility Directive 2014/30/EC through the following standards:

EN 55014-1: 2006 + A1: 2009 + A2: 2011

EN 55014-2: 1997 + A1: 2001 + A2: 2008

EN 61000-3-2: 2006 + A1: 2009 + A2: 2009

EN 61000-3-3: 2008

EN 61000-3-11: 2000

EN 61000-3-12: 2011

EN 61000-6-2: 2005

EN 61000-6-3: 2007





## INTERNATIONAL

### UNOX S.p.A.

Via Majorana 22 / 35010 Cadoneghe (PD) Italy  
Tel +39 049 8657511 / Fax +39 049 8657555  
info@unox.com



INVENTIVE SIMPLIFICATION

### EUROPE

#### ITALIA

UNOX S.p.A.  
E-mail: info@unox.it  
Tel.: +39 049 86 57 511

#### ČESKÁ REPUBLIKA

UNOX DISTRIBUTION s.r.o.  
E-mail: info.cz@unox.com  
Tel.: +420 241 940 000

#### РОССИЯ, ПРИБАЛТИКА И СТРАНЫ СНГ UNOX РОССИЯ

E-mail: info.ru@unox.com  
Tel.: +7 (499) 702-00-14

#### ESPAÑA

UNOX PROFESIONAL ESPAÑA S.L.  
E-mail: info.es@unox.com  
Tel.: +34 900 82 89 43

#### SCANDINAVIAN COUNTRIES

UNOX SCANDINAVIA AB  
E-mail: info.se@unox.com  
Tel.: +46 (0)768 716 422

#### UNITED KINGDOM

UNOX UK Ltd.  
E-mail: info@unoxuk.com  
Tel.: +44 1252 851 522

#### PORTUGAL

UNOX PORTUGAL  
E-mail: info.pt@unox.com  
Tel.: +351 918 228 787

#### DEUTSCHLAND

UNOX DEUTSCHLAND GmbH  
E-mail: info.de@unox.com  
Tel.: +49 2951 98760

#### FRANCE, BELGIUM & LUXEMBOURG

UNOX FRANCE s.a.s.  
E-mail: info@unox.fr  
Tel.: +33 4 78 17 35 39

#### ÖSTERREICH

UNOX ÖSTERREICH GmbH  
E-mail: bestellung@unox.com  
Tel.: +43 800 880 963

#### HRVATSKA

UNOX CROATIA  
E-mail: narudzbe@unox.com  
Tel.: +39 049 86 57 538

#### TÜRKİYE

UNOX TURKEY Profesyonel MutfaK Ekip-  
manları Endüstri ve Ticaret Limited Şirketi  
E-mail: info.tr@unox.com  
Tel.: +90 530 176 62 03

#### IRELAND

UNOX IRELAND  
E-mail: info.ie@unox.com  
Tel. +353 (0) 87 32 23 218

#### БЪЛГАРИЯ

UNOX BULGARIA  
E-mail: info.bg@unox.com  
Tel.: +359 88 23 13 378

### ASIA & AFRICA

#### MALAYSIA & SINGAPORE

UNOX (ASIA) SDN. BHD  
E-mail: info.asia@unox.com  
Tel.: +603-58797700

#### OTHER ASIAN COUNTRIES

UNOX (ASIA) SDN. BHD  
E-mail: info.asia@unox.com  
Tel.: +603-58797700

#### PHILIPPINES

UNOX PHILIPPINES  
E-mail: info.asia@unox.com  
Tel.: +63 9173108084

#### 대한민국

UNOX KOREA CO. Ltd.  
이메일: info.asia@unox.com  
전화: +82 2 69410351

### AMERICA & OCEANIA

#### U.S.A. & CANADA

UNOX Inc.  
E-mail: infousa@unox.com  
Tel.: +1 800 489 8669

#### MEXICO

UNOX MEXICO, S. DE R.L. DE C.V.  
E-mail: info.mx@unox.com  
Tel.: +52 1555 4314 180

#### BRAZIL

UNOX BRAZIL  
E-mail: info.br@unox.com  
Tel.: +55 11 98717-8201

#### U.A.E.

UNOX MIDDLE EAST DMCC  
E-mail: info.uae@unox.com  
Tel.: +971 55 426 3167

#### SOUTH AFRICA

UNOX SOUTH AFRICA  
E-mail: info.sa@unox.com  
Tel.: +27 845 05 52 35

#### INDONESIA

UNOX INDONESIA  
E-mail: info.asia@unox.com  
Tel.: +62 81908852999

#### 中华人民共和国

UNOX TRADING (SHANGHAI) CO. Ltd.  
电子邮件: info.china@unox.com  
电话: +86 21 56907696

#### COLOMBIA

UNOX COLOMBIA  
E-mail: info.co@unox.com  
Tel.: +57 350 65 88 204

#### AUSTRALIA

UNOX AUSTRALIA PTY Ltd.  
E-mail: info@unoxaustralia.com.au  
Tel.: +61 3 9876 0803

#### NEW ZEALAND

UNOX NEW ZEALAND Ltd.  
E-mail: info@unox.co.nz  
Tel.: +64 (0) 800 76 0803

L12547A1.D00-LDI-01 - Printed: 12-2019  
All images used are for illustrative purposes only.  
All features indicated in this catalogue may be subject to change and could be updated without notice.

UNOX.COM | FOLLOW US ON

