

COMPACT BRUSHLESS BLENDER no.66

OPERATING AND SERVICING MANUAL



IMPORTANT: documents included in this manual which must be kept:

- "CE" DECLARATION OF CONFORMITY
- WARRANTY CERTIFICATE

TRANSLATION OF THE ORIGINAL VERSION



Read the user manual before unpacking the appliance.

*Coffee grinders - Fruit juicers - Mixers - Blenders - Drinks dispensers - Planetary mixers
Cheese graters - Ice crushers - Mincers - Vegetable slicers - Dough mixer
Moulins à café - Presse-fruits - Mixers - Blenders - Distributeurs de boissons - Batteurs mélangeurs - Pétrin -
Râpes à fromage - Broyeurs à glaçons - Hache-viande - Coupe-légumes*

INTERNATIONALLY PATENTED MODELS



TABLE OF CONTENTS

"CE" DECLARATION OF CONFORMITY	3
SAFETY RULES	4
<i>CONTRAINDICATIONS:</i>	4
<i>ELECTRICAL CONNECTION:</i>	5
<i>1st USE:</i>	5
<i>END-OF-LIFE PRODUCT RECYCLING:</i>	5
DESCRIPTION OF THE APPLIANCE	6
INSTALLATION AND HANDLING:	6
Counter top installation	6
Recessed installation in the counter	6
USE OF THE APPLIANCE	7
<i>DESCRIPTION OF THE CONTROL PANEL:</i>	7
<i>USE:</i>	7
Switching on	7
Switching off the appliance	8
<i>RECIPES:</i>	8
<i>STANDBY MODE:</i>	8
<i>CLEANING:</i>	8
Cleaning the bowl:	8
Disinfecting the bowl:	9
<i>LID SAFETY FEATURE:</i>	9
Modification of the lid safety feature	9
<i>SERVICING:</i>	10
Spare parts:	10
Prolonged non-use:	11
Replacing the blade:	11
TROUBLESHOOTING GUIDE	12
The appliance will not start:	12
The blade does not turn:	12
Noise, vibrations, leaks around the blade of the bowl:	12
Problem with the recipes:	13
TECHNICAL FEATURES OF THE APPLIANCE	14
<i>TECHNICAL SPECIFICATIONS (1)</i>	14
<i>Electrical diagram 220-240 V 50/60 Hz:</i>	15
<i>Correlation table:</i>	16
CERTIFICAT DE GARANTIE	18
PLAQUE SIGNALÉTIQUE DE L'APPAREIL	18

"CE" DECLARATION OF CONFORMITY



THE MANUFACTURER:

SANTOS sas - 140-150, Av. Roger SALENGRO 69120 VAULX-EN-VELIN (LYON)
FRANCE

Declares that the appliance to be launched on the professional market, hereinafter:

Name: **COMPACT BRUSHLESS BLENDER**
Type number: **66**

complies with:

- the regulations defined by appendix 1 of the EU "Machinery" Directive **No. 2006/42/EC** and with national implementing legislation.
- the regulations of the following European directives and regulations:
 - No. 2014/35/UE (Low Voltage Directive)
 - No. 2014/30/EU (EMC Directive)
 - No. 2011/65/EU (RoHS Directive)
 - No. 2012/19/EU (WEEE Directive)
 - No. 1935/2004/EC (Regulation) on materials and objects intended to come into contact with food
 - No. 10/2011/EC (Regulation) relating to plastic materials intended for food contact

Harmonised European standards used to give presumption of conformity with the essential requirements of the directives mentioned above:

- **NF EN 12852+A1: 2010**, Food processing machinery – **Food processors and blenders** – Requirements for safety and hygiene.
This European Standard is a type C standard, as defined in EN ISO 12100. When provisions of this type C standard are different from those stated in type A or B standards, the provisions of the standard C types take precedence over the provisions of other standards. This standard provides the means to comply with the requirements of the "Machinery" Directive no. 2006/42/EC (see appendix ZA)
- NF EN ISO 12100: 2010, Safety of Machinery – General Principles for Design
- NF EN 60204-1+A1: 2009, Safety of machinery – Electrical equipment of machines – General requirements
- NF EN 1672-2: 2020, Food processing machinery – Basic concepts – Hygiene and cleanability requirements.
- NF EN 60335-1: 2013, Safety of household and similar electrical appliances
- NF EN 60335-2-64: 2004, Particular requirements for commercial electric kitchen machines.

Place: VAULX-EN-VELIN Date: **01/05/2021**
Signatory title: **CHAIRMAN AND CEO**
Name of signatory: **Aurélien FOUQUET**

Signature:



SAFETY RULES

When using, servicing or disposing of the appliance, always take care to follow these basic precautions.

Read the entire explanatory instructions

Keep this operating manual

Note: To facilitate understanding of the following paragraphs, please refer to the diagrams at the end of the manual

CONTRAINDICATIONS:



1. Do not use this appliance to process anything other than food.
2. Remove stones from fruit before placing them in the machine (e.g.: mangoes, apricots, peaches). Do not process fruit stones in the machine.
3. Do not use the appliance without properly positioning the bowl (1) with its lid (2) on the motor base (3).
4. Do not use the appliance without food in the bowl.
5. Do not fill the bowl beyond its maximum capacity corresponding to the value indicated on the side: 1.4 litres. Reduce the maximum capacity for thick mixtures.
6. The base (6) must not be immersed in water.
7. To protect against the risk of electrocution, do not immerse the base in water or any other liquid.
8. Do not use the appliance with a damaged power cord. It must be replaced either by an approved SANTOS dealer or the SANTOS company or by similarly qualified persons to avoid any hazards.
9. Unplug the appliance before any intervention on it: cleaning, servicing, maintenance.
10. Cleaning with a hose or pressure cleaner is not allowed.
11. Do not use an abrasive sponge to clean the bowl (1).
12. Do not insert or store kitchen utensils in the bowl.
13. Do not operate the appliance with a chipped, cracked or broken bowl or blade. Do not use a bowl with a loose blade.
14. It is prohibited to operate the appliance on a work surface with a slope greater than 10° to the horizontal plane. The 4 feet of the machine must always be supported on this work surface. The motor axis of the machine must always be vertical to the work surface.
15. It is forbidden to use replacement parts or accessories other than certified SANTOS original parts.
16. Press the On/Off switch (4) when the appliance is not in operation.
17. Do not connect multiple appliances on the same power outlet.
18. Do not use this appliance outdoors.
19. Do not place the appliance close to a heat source.
20. This appliance is a professional device, intended exclusively for professional use. It is not intended for domestic use.



21. This appliance is not intended for use by persons (including children) with reduced physical, sensory or mental capabilities, or persons with a lack of experience or knowledge, unless under the supervision or with prior instruction concerning use of the appliance by a person responsible for their safety.
Children should be supervised to ensure that they do not play with the appliance.
22. This appliance is intended for collective use, e.g. in restaurant kitchens, canteens, hospitals and small commercial businesses such as bakeries, butchers, etc., but not for the continuous mass production of food.

ELECTRICAL CONNECTION:

- Single-phase electrical power connection:
 - 220-240 V 50/60 Hz

Note: This appliance can operate in both 50 Hz and 60 Hz without any adjustment needed.

Line protection: the appliance must be plugged into a standard electrical outlet: 2 poles + earth. The installation must be fitted with an RCD and a fuse rated at 16 A. **Earthing the installation is mandatory.**

PLEASE NOTE:



Before connecting the appliance, check the correlation between the mains voltage and that of your appliance. Its value is shown:

- either on the identification plate under the appliance.
- or on the identification plate on the last page of this manual.

1st USE:

Properly clean the parts in contact with food: bowl (1) lid (2).

See the “cleaning” chapter

END-OF-LIFE PRODUCT RECYCLING:



This appliance is marked by the selective sorting symbol relating to electric and electronic waste. This means that this product should be supported by a selective collection system in accordance with Directive 2012/19/EU (WEEE) – Professional Equipment section – so it can either be recycled or dismantled to minimise any environmental impact.

For more information, please contact your dealer or the SANTOS company.

To dispose of or recycle the appliance components, please contact a specialised company or the SANTOS company.

Electronic products that are not sorted are potentially dangerous for the environment.

Packaging materials must be disposed of or recycled in accordance with current regulations.

Allocation table of materials comprising the appliance (% of mass)

Steel mass	Plastic mass	Aluminium mass	Zinc mass	Copper mass	Misc. mass*
39.1%	25.2%	12.6%	11.1%	4.9%	7.1%

* Misc. mass, e.g. switches, circuit boards, capacitors, electrical cords, etc.

DESCRIPTION OF THE APPLIANCE

- The appliance is a professional device, intended exclusively for professional use. It is not intended for domestic use.
- The appliance is intended for the preparation of cocktails, smoothies and all preparations containing crushed ice and blended fruit to be made in bars, cafés, hotels, restaurants.
- The appliance consists of a blender bowl, a motor base with an On/Off switch, an electronic module and control panel.
- It comes with nine recipes to prepare the required preparations.

INSTALLATION AND HANDLING:

Check that the power plug is always accessible regardless of the installation mode (counter top version or recessed version).

Counter top installation

Only one person is required for handling the appliance. For ease of use, it is advisable to place the appliance on a table or work surface, so as to have the control panel in front of you (recommended height: 90 cm).

Recessed installation in the counter

This installation requires a cut in the worktop (**fig.3**).

Before making this cut, make sure the appliance is perfectly usable once recessed.

The cut-out of the work surface corresponds to a rectangle: **154 mm (wide) x 164 mm (deep)**.

- Make sure you have a minimum clearance of 90 mm under the worktop.
- Heightwise, the free zone must be 400 mm
- The minimum lateral clearance must be 100 mm

Cut-out and installation plans are available for download on our website in the directory of blender No. 66.

Multiple recessed: It is advisable to leave a gap of 100 mm between two cut-outs.

Transformation of the appliance to fit the recessed installation.

- Unplug the appliance from the mains.

- Remove the bowl (1).
- Tip the appliance onto its back.
- Using a Torx screwdriver, remove the 4 screws inside the feet.
- Remove the motor casing (6).

You can position the appliance as such into the cut-out in the worktop.

USE OF THE APPLIANCE

DESCRIPTION OF THE CONTROL PANEL:



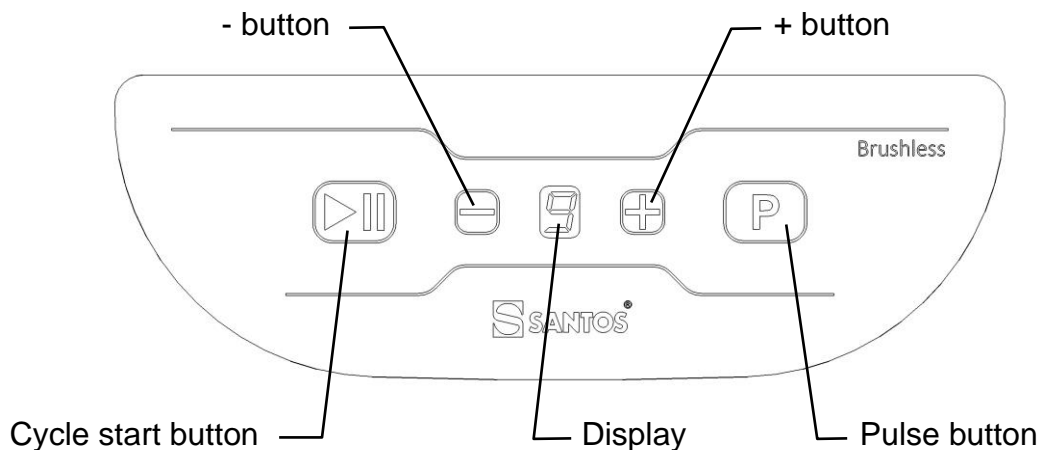

The control panel (5) comprises a display indicating the recipe number and four control buttons:



USE:

Note: The appliance can only be started if the lid (2) is properly positioned on the bowl.

Switching on

1. Switch the appliance on by pressing on the On/Off switch (4).
2. In the bowl (1), place soft food first, followed by harder ingredients and finish with ice cubes. Evenly sized food makes it easier to blend the recipe.
3. Place the lid (2) on the bowl, ensuring it is properly positioned.
4. When the motor is completely stopped, place the bowl correctly on the bowl mat (7).
The display stops flashing.
5. Select the recipe using the  and  buttons.
6. Press the "Cycle start" button .
7. The recipe number flashes during the course of the cycle.
8. Wait for the end of the cycle.
9. At any time, it is possible to switch to maximum speed by pressing the Pulse button .

Switching off the appliance

The appliance is switched off:

- either automatically, at the end of the cycle
- or manually, by pressing the Cycle start button , by pressing the On/Off switch (4), by lifting the lid of the bowl or by lifting the bowl.

Note: it is not advisable to remove the bowl when the motor is rotating.

RECIPES:

There are 9 saved recipes: they consist of several sequences of different speeds. They are detailed in the "Recipe List" booklet supplied with the appliance.

STANDBY MODE:

The brightness of the digital display automatically dims when the appliance has not been used for 10 minutes.

Press any key on the control panel to return to the normal brightness.

The appliance turns off automatically when it has not been used for 30 minutes.

This time can be increased up to 10 hours: see the procedure in the "**Searchable and modifiable settings**" paragraph.

CLEANING:

IMPORTANT:



- **In all cases, stop the appliance and unplug its power cord (8).**
- **Cleaning with a hose or pressure cleaner is not allowed.**
- The motor base (3) must not be immersed in water.
- Do not use an abrasive sponge to clean the bowl (1), lid (2) and the control panel (5).
- Do not close the bowl shut when the appliance is stored (remove the lid (2))
- Handle the blade carefully, due to the risk of cutting.
- Do not knock the bowl against a surface to loosen the ingredients, use a flexible spatula.

It is recommended to clean the appliance once the work is completed.

Cleaning will be easier if you do not wait until the pulp has dried.

The motor casing (6) can be cleaned with a soft damp sponge.

Cleaning the bowl:

Note: Although the bowl and lid can be washed in the dishwasher, it is advisable not to do

so to increase their lifespan.

1. Empty the contents of the bowl and rinse under running water to remove the maximum amount of solid residue.
2. Fill the bowl with 600 ml of warm water (40-45 °C), add 2 drops of household washing up liquid, close the bowl with its lid and start the cleaning cycle (30 seconds): see the procedure in the "**Searchable and modifiable settings**" paragraph.
3. Rinse thoroughly with clean water.

Disinfecting the bowl:

Use the following procedure to disinfect perfectly.

1. Clean the bowl and lid (see previous section).
2. Fill the bowl with 1 litre of a disinfectant solution (8 ml of bleach to 2.6% active chlorine and fill with 1 litre of cold water (20-30 °C)).
3. Close the bowl with its lid and start the cleaning cycle (30 seconds), see the procedure in the "**Searchable and modifiable settings**" paragraph
4. At the end of the cycle, leave the solution to act for 2 minutes.
5. Rinse thoroughly with clean water.

LID SAFETY FEATURE:

Note: The appliance can only be started if the lid (2) is properly positioned on the bowl.

Modification of the lid safety feature



"Pause" mode (Default)



During the course of a cycle, lifting the bowl (1) or the lid (2) causes the motor to stop but does not deselect the chosen recipe. When the bowl is replaced with the lid or when the lid is replaced on the bowl, the cycle resumes.

Note:

















It is possible to disable the automatic restart or pause time.
Refer to the "**Searchable and modifiable settings**" paragraph.

SEARCHABLE AND MODIFIABLE SETTINGS:

Some information on the appliance can be viewed or modified in a specific menu accessed by pressing simultaneously on the  and  buttons for 5 seconds: a flashing letter "C" appears.

By using the  or  buttons, scroll through the letters that correspond to the following functions:

- "C": cleaning cycle.
Push the  button to start the cycle.
- "c": display of the number of recipes produced since the appliance was manufactured.

- Push the  button to launch the display.
92 recipes appear: 0-0-0-0-9-2.
- Press the Pulse button  to exit the menu.
- **"b"**: adjustment of the display brightness.
Press the  button to adjust the brightness.
Push the  button to dim the brightness or the  button to increase it.
Push the  button to complete the setting and exit the menu.
 - **"t"**: setting of the appliance's standby time delay.
Push the  button to set the standby time.
Using the  or  buttons, select a number between 1 and 9:
1 = 30 mins; 2 = 40 mins; 3 = 1 hour; 4 = 1.5 hours; 5 = 2 hours; 6 = 3 hours;
7 = 4 hours; 8 = 6 hours; 9 = 10 hours
Push the  button to confirm the time chosen and exit the menu.
 - **"P"**: setting of the pause time.
Press the  button to modify.
Using the  or  buttons, select a number between 0 and 9.
0: Pause function disabled: the motor stops and the recipe is reset when the lid is opened or bowl removed.
1: 1-second pause: the user has 1 second to replace the lid or bowl in position so that the selected recipe continues to run to the end, otherwise it is cancelled.
2: 2-second pause.
The maximum time that may be set for the pause is 9 s.
Push the  button to complete the setting and exit the menu.
 - **"F"**: display of the version of the computer program used to operate the appliance.
Push the  button to launch the display.
For example, a 1.02 program will appear: 1 - . - 0 - 2.
Press the  button to exit the menu.

SERVICING:

Before working on the appliance, it is essential to unplug the sector.

Spare parts:

This machine requires no special servicing. The roller bearings are lubricated for life. If work is required to replace worn parts such as the bearing, the blade, the electrical and other components, refer to the list of components (see the exploded diagram at the end of the manual).

For **ordering spare parts** (See references in the exploded diagram at the end of manual), state:

- **the type,**
- **the appliance's serial number and**
- **the electrical characteristics**

recorded under the appliance.



Prolonged non-use:

This appliance presents no contraindications to prolonged inactivity. We simply recommend cleaning it before use and checking the condition of the components of the appliance (e.g. power cord, seals and other parts).

Replacement of the drive system:

Motor driving side (female):

Loosen the 3 screws (**23**). Remove the coupling plate (**21**) and remove the coupling seal (**2**) using a tip or a blade (**fig.3 and fig.4**)

Hold down the motor's drive body (**20**) using multigrip pliers, and unscrew the fastening screw (**19**) using a TORX spanner (anticlockwise) (**fig.5**).

Blade driving side (male):

The blade drive is integrated into the bearing (**10**) of the bowl. Everything (drive - bearing - roller bearings) needs to be replaced

- Turn the bowl over.
- Using a large flat screwdriver, loosen the bearing fastening ring (**14**) (anticlockwise) (**fig.6 and fig.7**).
- Remove the bearing fitted with the blender's blade from the bowl.

(See the next section on how to dismantle the blade)

Replacing the blade:

Dismantling the complete bearing *(See previous section)*

Dismantling the blade

Hold the blade coupling (**25**) using multigrip pliers and unscrew the fastening bolt (**11**) using a 13 hexagonal spanner (anticlockwise) (**fig.8**).

Mounting the blade

Be sure to observe the order of assembly of the different components (**fig.7**):

1. Lip seal (**12**) (correctly position the lip downwards),
2. Blade (**9**) (holes facing upwards),
3. Tightening nut (**11**) (screw the nut by hand, ensuring that the blade is correctly positioned on the square of the axis).
4. Tighten the nut.

Bearing assembly on the bowl



- Place the bearing seal (13) on the bearing (10)
- Place the clamping ring seal (15) on the fastening ring (14).
- Place the bearing (10) in the bowl (1)
- Screw the tightening ring, being careful not to pull the ring seal from its housing
- Tighten firmly by hand.

TROUBLESHOOTING GUIDE

It is necessary to identify what has caused the appliance to stop working. In any case, if the problem persists, switch off (unplug the power cord (8) and call in the maintenance service or contact an approved SANTOS dealer.

The appliance will not start:

The display is off:

- Check: the mains supply, the condition of the power cord (8).
- Press the On/Off switch (4).
- Disconnect and reconnect the power supply cord.
- It may be that after prolonged use of the appliance, the engine has reached its maximum temperature: in this case, wait for the motor to cool (30 to 50 minutes) and restart the appliance.
- An excessively hard body or excessive load in the bowl may cause motor overload: in this case, switch off the appliance (unplug the power supply cord (8). Under the appliance (fig.10), push the button (26) to reset the overcurrent protector. If the button does not remain in the "reset" position, allow the appliance to cool before renewing the operation.

The display flashes:

- This message indicates that the lid is not in place: reposition the lid on the bowl properly.
- Remove all foreign bodies that could activate the buttons, clean the control panel.

Note: The appliance cannot start if the bowl is not positioned on the appliance.

The letter "E" appears:

- The supply voltage is not appropriate: check the voltage of your power supply.
- The temperature of the appliance's electronic board is too high: wait a few minutes for it to cool.

The blade does not turn:

- Check that there are no foreign bodies stuck in the bowl.
- Check the status of the drive system (motor and blade).

Noise, vibrations, leaks around the blade of the bowl:

- Check the tightness of the blade (first dismantle the blade bearing)
- Replace the bearing seals

See "replacing the blade" chapter.

If the problem persists, switch off (unplug the power cord (8) and call in the maintenance service or contact an approved SANTOS dealer.

Problem with the recipes:

A few rules to better understand the functioning of a blender and to adapt recipe cycles to the products used.

Note: Do not overload the appliance: it is better to do a recipe in two small batches rather than double the quantities and cycle time: prolonged operation heats the ingredients by friction and distorts the desired texture of the recipe.

The final mixture is too hot. Once the smooth mixture is obtained, continuing to blend warms the mixture: *reduce speed or time of the recipe.*

The final mixture is not smooth:

- The recipe is not appropriate for the quantity and products used. Reduce the amount of food in the bowl, increase the cycle, reduce the size of food (evenly sized food makes blending easier).
- Liquid is required to convey solid food to the blade. Increase the amount of liquid. Pour the liquid into the bowl before any solid food.

Ice-cubes stick to the walls of the bowl:

- Use the special program for ice-cubes No. 6.
- Reduce the amount of ice-cubes when they are processed without liquid
- It is better to add liquid to ice-cubes, always starting with the liquid.

The mixture "bounces" in the bowl at high speed:

- Reduce and adapt the speed to the amount processed so that the blade is permanently in the mixture. The recipe will be faster to make and smoother. High speeds are not suitable for recipes in small quantities.
- Increase the amount of product to be processed.

TECHNICAL FEATURES OF THE APPLIANCE

TECHNICAL SPECIFICATIONS (1)

Model 66		Single-phase
Power Voltage	(V)	220-240
Frequency	(Hz)	50/60
Power consumption	(W)	1,005
Maximum intensity	(A)	5
Speed:	(rpm)	1,200-13,000
Effective capacity of the bowl	(L)	1.4
Number of recipes		9
Pulse		Yes
Touch control panel		Yes
Adjustable brightness display		Yes
Cycle counter		Yes
Adjustable standby mode		Yes
Lid safety feature		Yes
Motor overheating safety feature		Yes
Surge safety feature		Yes
Intermittent operation (3)		60 seconds ON and 60 seconds OFF
Dimensions: Height	(mm)	393
Width	(mm)	197
Depth	(mm)	233
Weight: Net weight	(kg)	6.2
Packaged weight	(kg)	7.3
Noise: (2) L_{pA} uncertainty $K_{pA} = 2.5$ dB <i>Maximum speed & load</i>	(dBA)	70

(1) These values are given for information purposes. The exact electrical characteristics of your appliance are noted on the identification plate.

(2) Noise level measured as the acoustic pressure of the activated appliance according to standards NF EN 12852: 2010, ISO 11201: 1995 and ISO 4871: 1996.

Appliance positioned on a worktop 75 cm from the ground. Microphone turned towards the appliance 1.6 m above the ground and 1 m from the appliance.

(3) 1 min / 1 min cycle:

The professional appliance is intended for intermittent use in a cycle of 1 minute ON and 1 minute OFF. This cycle corresponds to the running time to achieve the function and downtime to prepare and serve products processed in accordance with the requirements of the standard: EN 60335-2-64+A1: 2004 Part 2-64: Particular requirements for commercial electric kitchen machines.



Electrical diagram 220-240 V 50/60 Hz

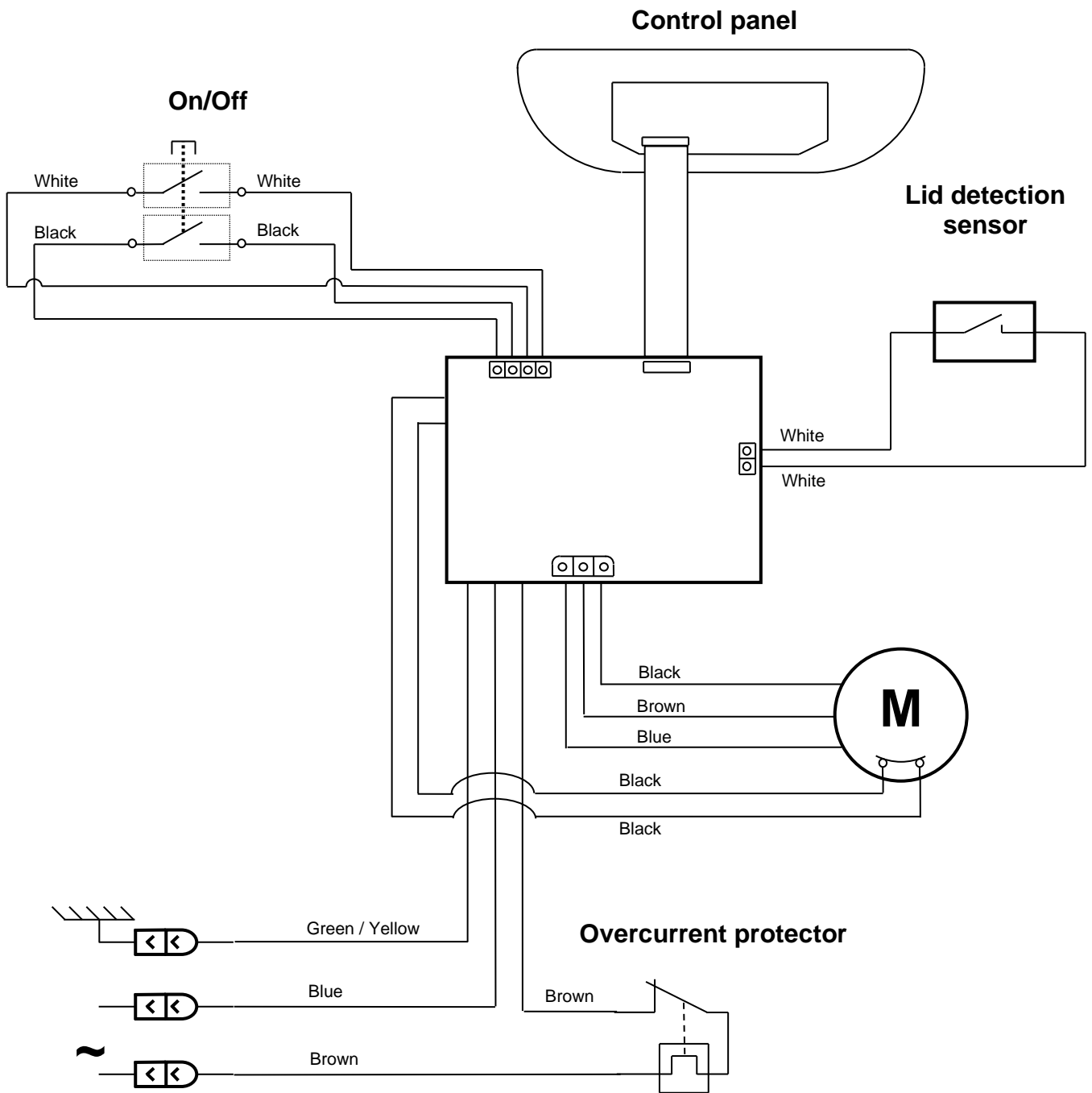

Correlation table

REP	Name
1	Bowl
2	Bowl lid
3	Motor base
4	On/Off switch
5	Control panel
6	Motor casing
7	Bowl mat
8	Power outlet
9	Blade
10	Blade bearing
11	Blade tightening nut
12	Blade axis seal
13	Bearing seal
14	Bearing tightening ring
15	Bearing tightening ring seal
19	Tightening screw of the motor drive
20	Motor drive body
21	Motor drive plate
22	Motor drive seal
23	Motor drive plate screw
24	Table top seal
25	Blade drive
26	Overcurrent protector

Figures

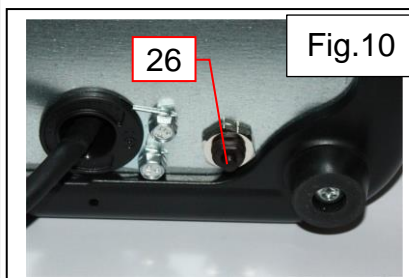
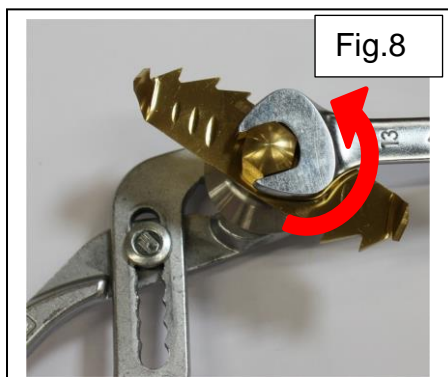
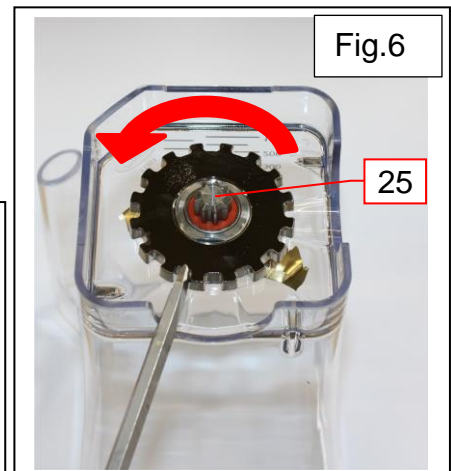
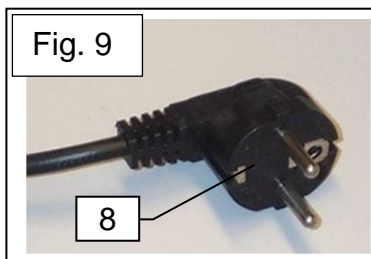
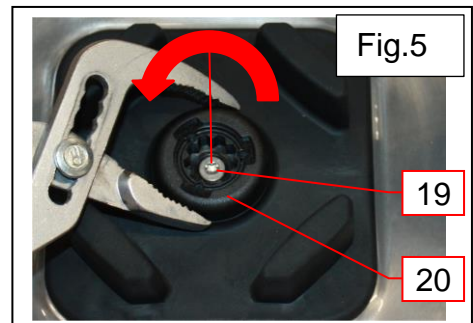
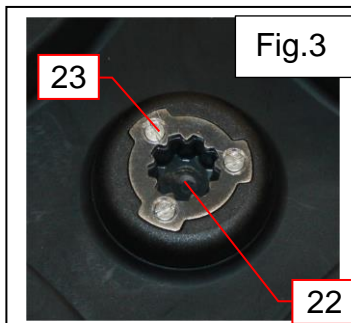
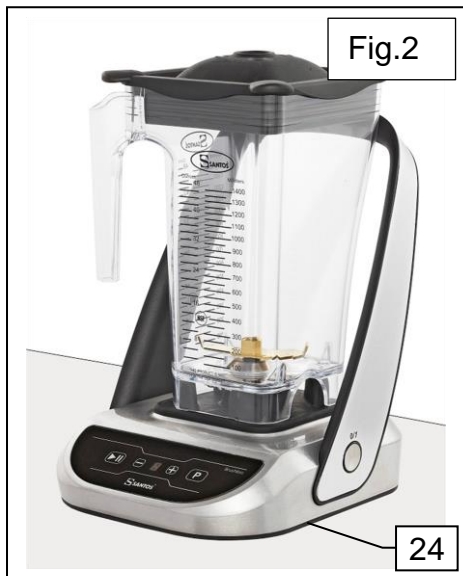
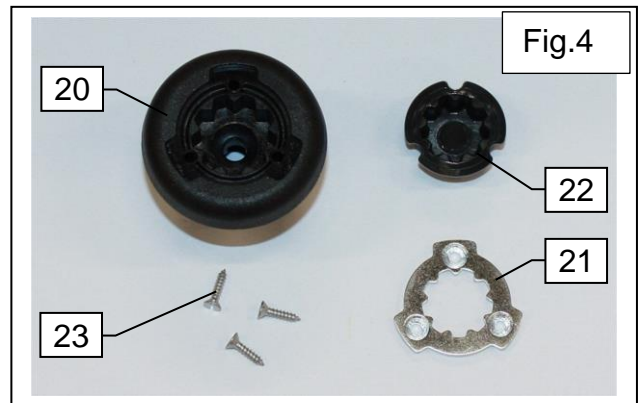
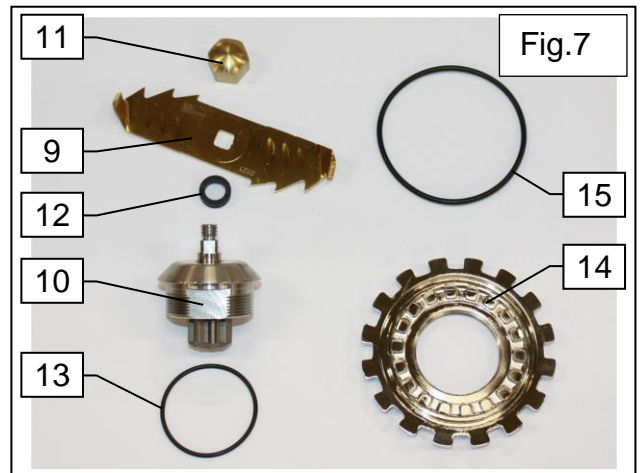

CERTIFICAT DE GARANTIE

GARANTIE

Depuis le 01.01.95, tous nos appareils **sont conformes CE et revêtus du label CE**. Notre garantie est de **vingt-quatre mois** à partir de la date de fabrication figurant sur la plaque signalétique, sauf en ce qui concerne les moteurs asynchrones (composé d'un rotor et d'un stator) qui sont garantis pour une durée de 5 ans à compter de leur date de fabrication. La garantie est strictement limitée au remplacement gratuit de toute pièce d'origine reconnue par nous défectueuse à la suite d'un défaut ou d'un vice de construction et identifiée comme appartenant à l'appareil considéré. Elle ne s'applique pas aux avaries résultant d'une installation ou d'une utilisation non-conforme aux prescriptions accompagnant chaque appareil (manuel d'utilisation) ou dans le cas d'un manque évident d'entretien ou de non observation des règles élémentaires de sécurité électriques. La garantie ne s'applique pas en cas d'usure naturelle. Tout remplacement de pièce sous garantie est effectué après renvoi de la pièce défectueuse en nos ateliers en port payé, accompagnée d'une **copie de la Déclaration de conformité** sur laquelle figure le numéro de série de l'appareil. Tout appareil est muni d'une **plaque signalétique** conforme CE et dont un double figure dans la Déclaration de conformité (N° de série, date de fabrication, caractéristiques électriques...). En cas d'avarie grave jugée réparable uniquement dans nos ateliers, et **après accord préalable de nos services**, tout appareil sous garantie est expédié par le Distributeur en port payé. En cas de réparation ou reconditionnement d'appareil hors garantie, le transport aller-retour est à la charge du Distributeur. Les pièces et main-d'œuvre sont facturées aux tarifs en vigueur (tarif pièces détachées – tarif horaire – main-d'œuvre). Il peut être fourni un devis préalable.

Les moulins à café non munis de meules originales SANTOS ne sont pas pris sous garantie. Les conditions de garantie, réparation, reconditionnement, des moulins à café espresso font l'objet d'une notice spécifique. Notre garantie ne s'étend pas au paiement de pénalités, à la réparation des préjudices directs ou indirects et notamment à tout manque à gagner résultant de la non-conformité ou défectuosité des produits, la responsabilité globale de SANTOS étant limitée au prix de vente du produit livré et à l'éventuelle réparation des produits défectueux.

En cas de révélation d'une défectuosité pendant la période de garantie, le Distributeur doit, sauf accord contraire écrit de SANTOS, indiquer à son client, de cesser toute utilisation du produit défectueux. Une telle utilisation dégraderait SANTOS de toute responsabilité.

PLAQUE SIGNALÉTIQUE DE L'APPAREIL